

SECTION A-A

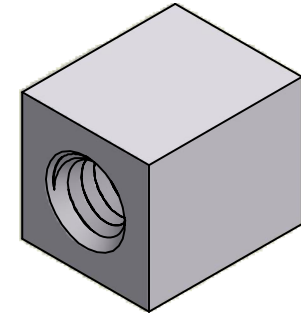

ISO SCALE 3 : 1

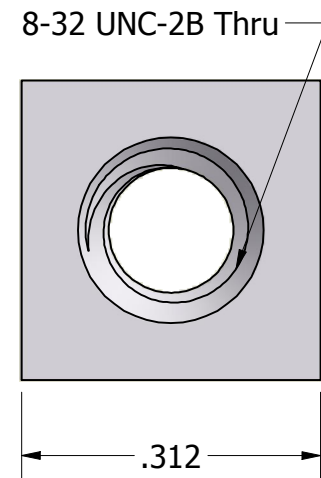
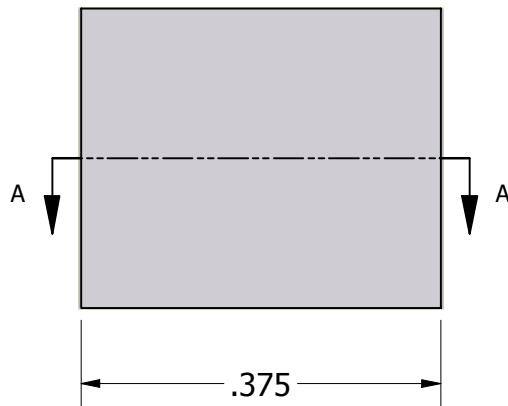

Tolerances Unless Otherwise Specified:

.xx Decimal: $\pm .02$
.xxx Decimal: $\pm .005$
Fraction: $\pm 1/64$
Angle: $\pm 2^\circ$

LYN-TRON, INC.

Part Number:

AA6962-0832-0.375

Description:

5/16 Square Standoff

Drawn By:

COURTNEYS09/09/2011

Gauge:

Material:

Aluminum (RoHS)

Scale:

5 : 1