

SECTION A-A

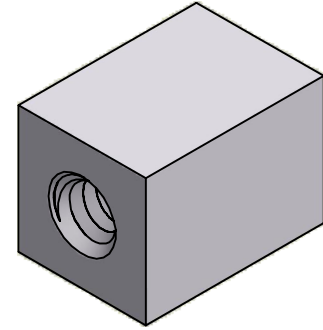

ISO SCALE 3 : 1

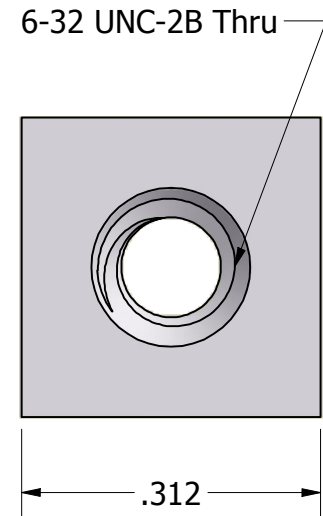
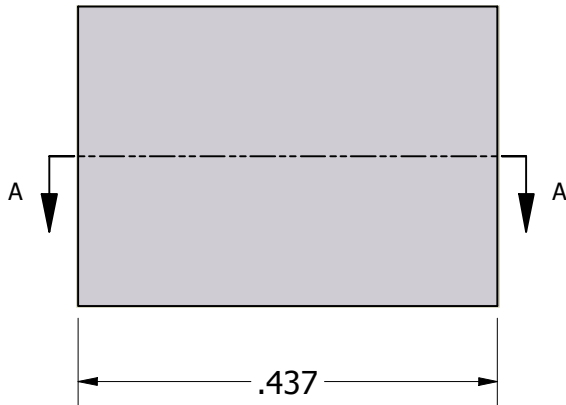

Tolerances Unless Otherwise Specified:

.xx Decimal: $\pm .02$
.xxx Decimal: $\pm .005$
Fraction: $\pm 1/64$
Angle: $\pm 2^\circ$

LYN-TRON, INC.

Part Number:
AA6962-0632-0.437

Description:
5/16 Square Standoff

Drawn By:
COURTNEYS09/09/2011

Gauge:

Material:
Aluminum (RoHS)

Scale:
5 : 1