

SECTION A-A

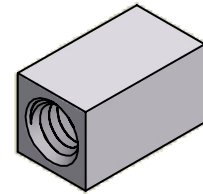

ISO SCALE 2 : 1

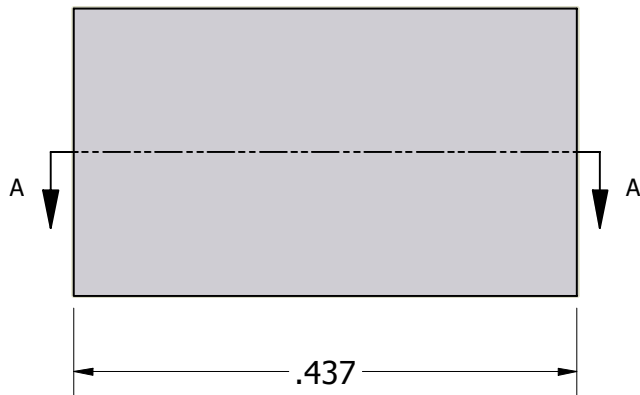

8-32 UNC-2B Thru

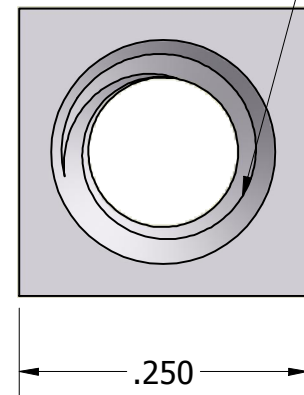

Tolerances Unless Otherwise Specified:

**.xx Decimal:** ± .02  
**.xxx Decimal:** ± .005  
**Fraction:** ± 1/64  
**Angle:** ± 2°

**LYN-TRON, INC.**

Part Number:

**AA6961-0832-0.437**

Description:

**1/4 Square Standoff**

Drawn By:

**RICKZ 09/07/2011**

Gauge:

Material:

**Aluminum (RoHS)**

Scale:

**6 : 1**