

SECTION A-A

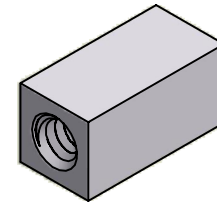

ISO SCALE 2 : 1

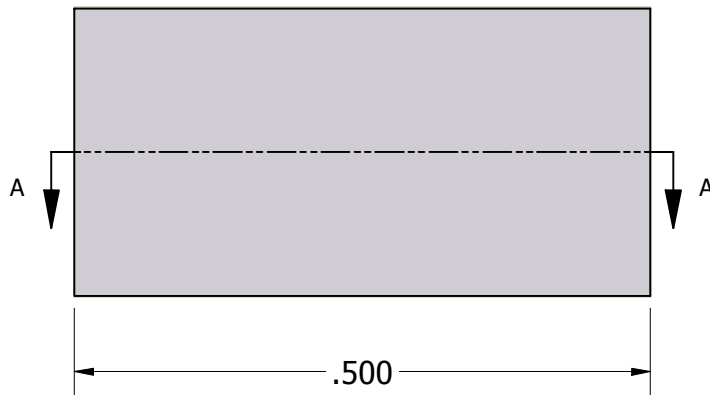

6-32 UNC-2B Thru

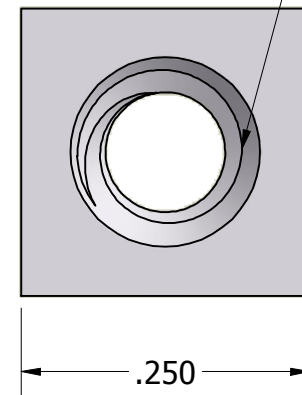

Tolerances Unless Otherwise Specified:

.xx Decimal: ± .02
.xxx Decimal: ± .005
Fraction: ± 1/64
Angle: ± 2°

LYN-TRON, INC.

Part Number:
AA6961-0632-0.500

Description:
1/4 Square Standoff

Drawn By:
RICKZ 09/07/2011

Gauge:

Material:
Aluminum (RoHS)

Scale:
6 : 1