

SECTION A-A

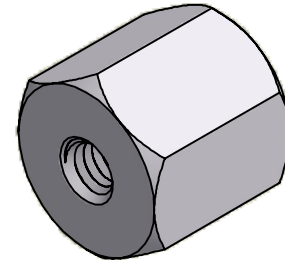

ISO SCALE 2 : 1

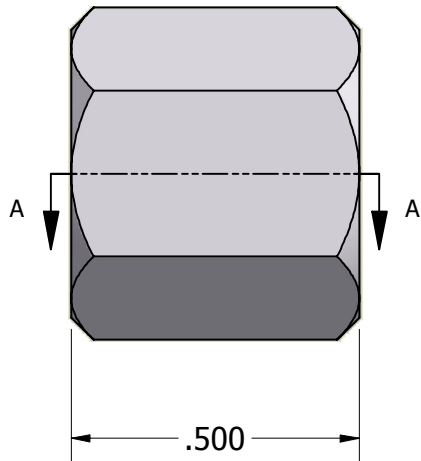

8-32 UNC-2B Thru

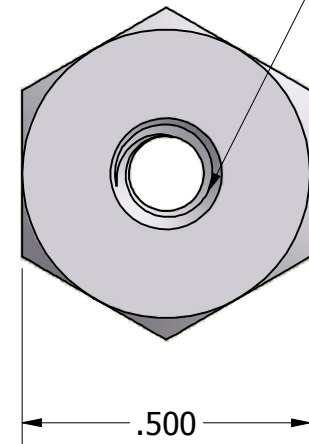

Tolerances Unless Otherwise Specified:			
.xx Decimal:	± .02		
.xxx Decimal:	± .005	Part Number:	
Fraction:	± 1/64	<b>AA6955-0832-0.500</b>	
Angle:	± 2°	Description:	
		<b>1/2 Hex Standoff</b>	
Drawn By:	Gauge:	Material:	Scale:
<b>JEFFN</b>	<b>06/26/2010</b>	<b>Aluminum (RoHS)</b>	<b>3 : 1</b>