

SECTION A-A

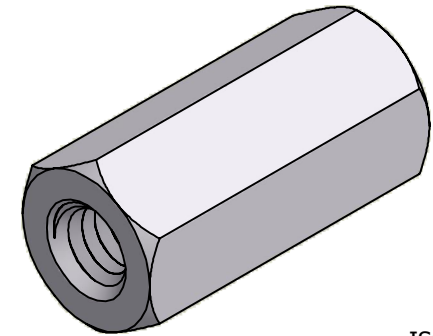

ISO SCALE 3 : 1

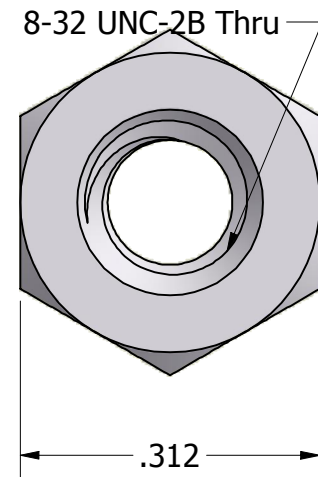
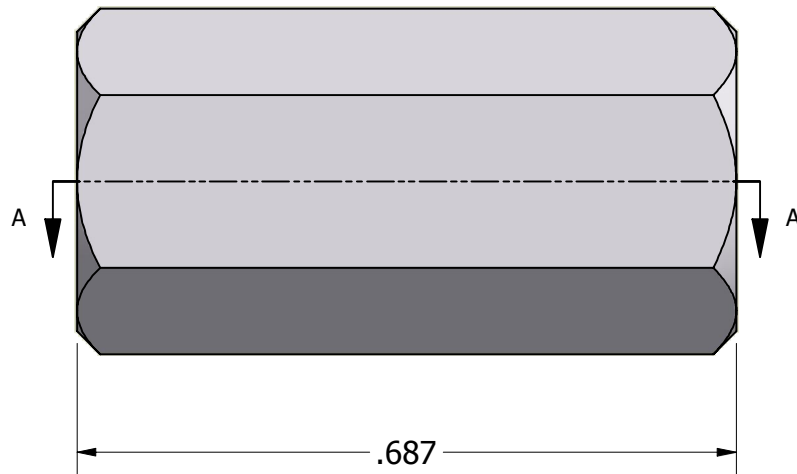

Tolerances Unless Otherwise Specified:

.xx Decimal: ± .02
.xxx Decimal: ± .005
Fraction: ± 1/64
Angle: ± 2°

LYN-TRON, INC.

Part Number:
AA6952-0832-0.687

Description:
5/16 Hex Standoff

Drawn By:
JEFFN 06/26/2010

Gauge:

Material:
Aluminum (RoHS)

Scale:
5 : 1