

SECTION A-A

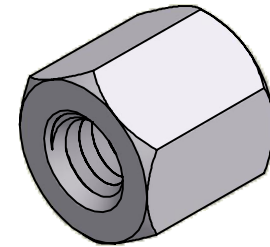

ISO SCALE 3 : 1

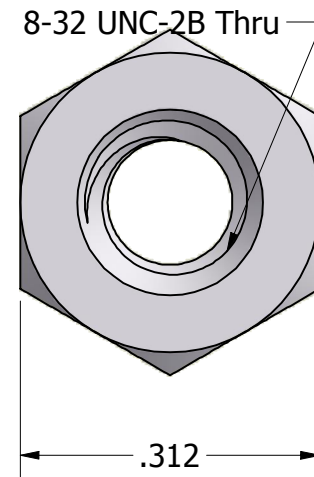
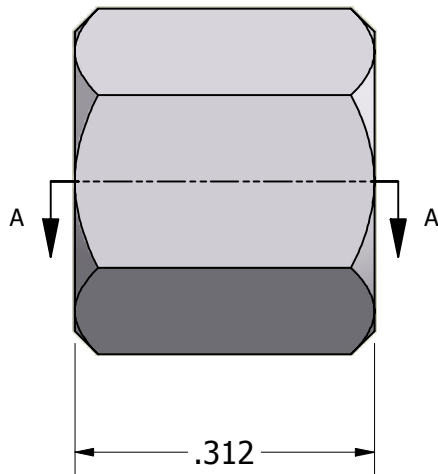

Tolerances Unless Otherwise Specified:			
.xx Decimal:	± .02		
.xxx Decimal:	± .005	Part Number:	
Fraction:	± 1/64	AA6952-0832-0.312	
Angle:	± 2°	Description:	
		5/16 Hex Standoff	
Drawn By:	Gauge:	Material:	Scale:
JEFFN	06/26/2010	Aluminum (RoHS)	5 : 1