

SECTION A-A

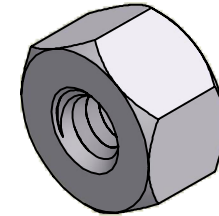

ISO SCALE 3 : 1

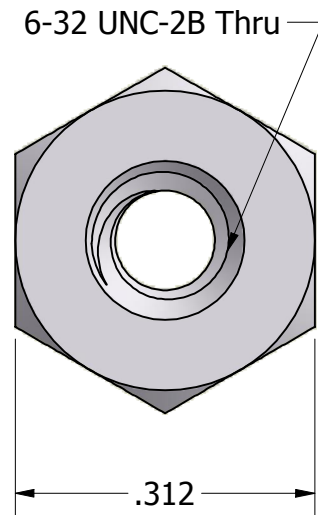
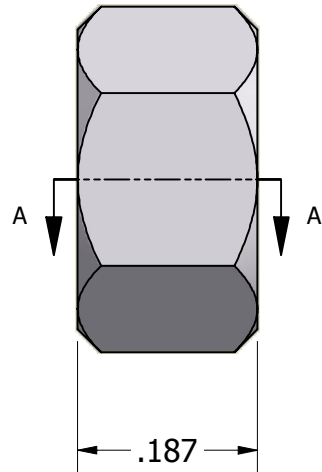

Tolerances Unless Otherwise Specified:			
.xx Decimal: ± .02 .xxx Decimal: ± .005 Fraction: ± 1/64 Angle: ± 2°			
Part Number:		AA6952-0632-0.187	
Description:		5/16 Hex Standoff	
Drawn By:	Gauge:	Material:	Scale:
JEFFN 06/26/2010		Aluminum (RoHS)	5 : 1