

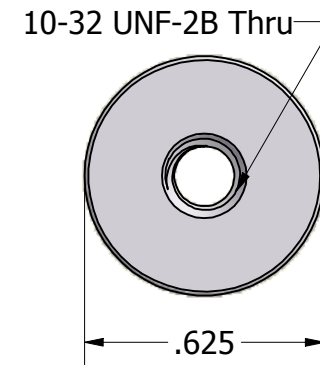

SECTION A-A

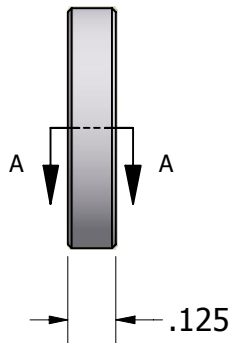

ISO SCALE 1 : 1



Tolerances Unless Otherwise Specified:			
.xx Decimal: ± .02 .xxx Decimal: ± .005 Fraction: ± 1/64 Angle: ± 2°			
Part Number:		AA6946-1032-0.125	
Description:		5/8 Round Standoff	
Drawn By:	Gauge:	Material:	Scale:
JEFFN 06/26/2010		Aluminum (RoHS)	2 : 1