

SECTION A-A

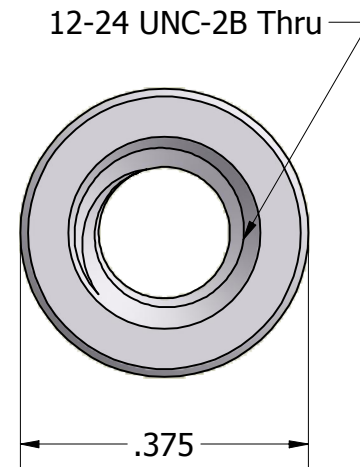

ISO SCALE 2 : 1

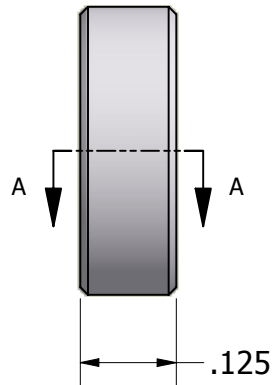

Tolerances Unless Otherwise Specified:			
.xx Decimal: ± .02 .xxx Decimal: ± .005 Fraction: ± 1/64 Angle: ± 2°			
Part Number:		AA6943-1224-0.125	
Description:		3/8 Round Standoff	
Drawn By:	Gauge:	Material:	Scale:
JEFFN 06/25/2010		Aluminum (RoHS)	4 : 1