

SECTION A-A

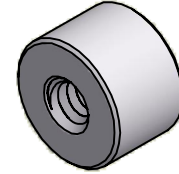

ISO SCALE 2 : 1

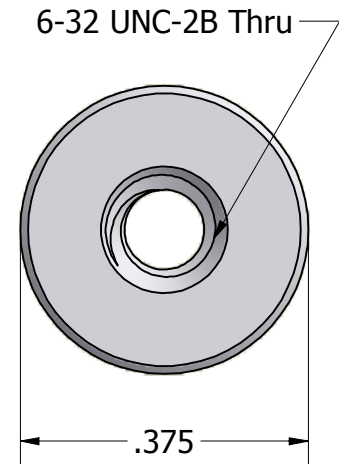
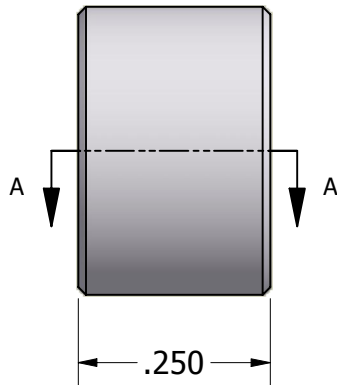

Tolerances Unless Otherwise Specified:

.xx Decimal: ± .02
.xxx Decimal: ± .005
Fraction: ± 1/64
Angle: ± 2°

LYN-TRON, INC.

Part Number:
AA6943-0632-0.250

Description:
3/8 Round Standoff

Drawn By:
JEFFN 06/25/2010

Gauge:

Material:
Aluminum (RoHS)

Scale:
4 : 1