

SECTION A-A

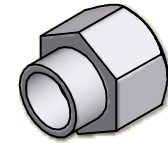

ISO SCALE 3 : 1

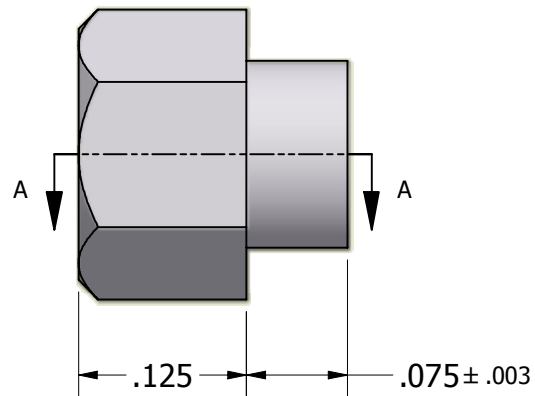

3-48 UNC-2B Thru

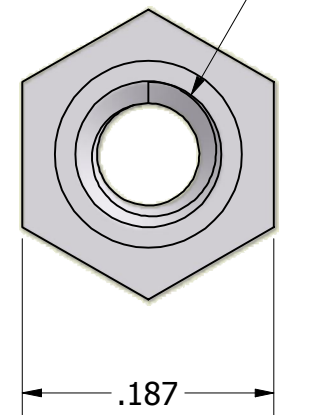

Tolerances Unless Otherwise Specified:

.xx Decimal: $\pm .02$
.xxx Decimal: $\pm .005$
Fraction: $\pm 1/64$
Angle: $\pm 2^\circ$

LYN-TRON, INC.

Part Number:

AA6936A-0.125

Description:

3/16 Hex Swage Standoff

Drawn By:

JEFFN

06/24/2010

Gauge:

Material:

Aluminum (RoHS)

Scale:

7 : 1