

SECTION A-A

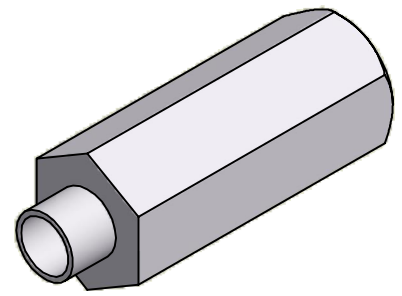

ISO SCALE 3 : 1

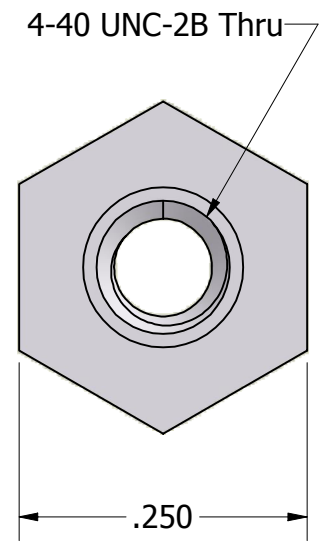
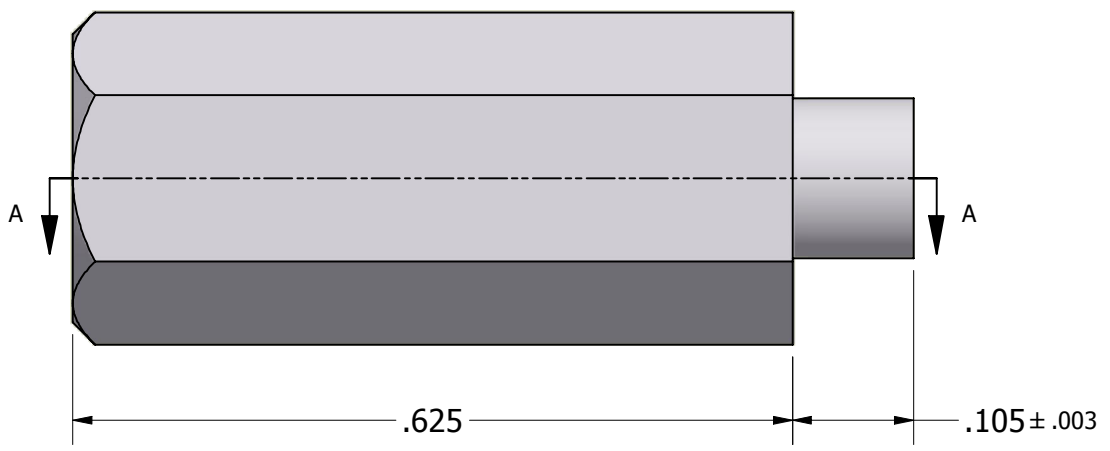

Tolerances Unless Otherwise Specified:  
 .xx Decimal: ± .02  
 .xxx Decimal: ± .005  
 Fraction: ± 1/64  
 Angle: ± 2°

**LYN-TRON, INC.**

Part Number:  
**AA6926B-0.625**

Description:  
**1/4 Hex Swage Standoff**

Drawn By:  
**COURTNEYS09/14/2011**

Gauge:

Material:  
**Aluminum (RoHS)**

Scale:  
**6 : 1**