

SECTION A-A

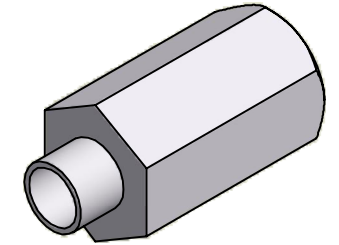

ISO SCALE 3 : 1

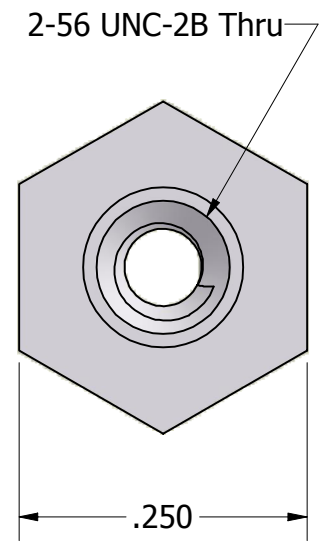
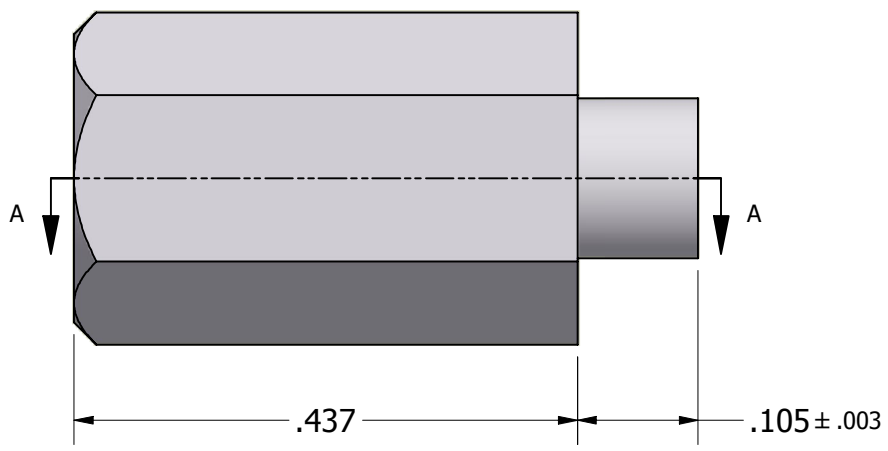

Tolerances Unless Otherwise Specified:
 .xx Decimal: ± .02
 .xxx Decimal: ± .005
 Fraction: ± 1/64
 Angle: ± 2°

LYN-TRON, INC.

Part Number:
AA6925B-0.437

Description:
1/4 Hex Swage Standoff

Drawn By:
COURTNEYS09/14/2011

Gauge:

Material:
Aluminum (RoHS)

Scale:
6 : 1