

SECTION A-A

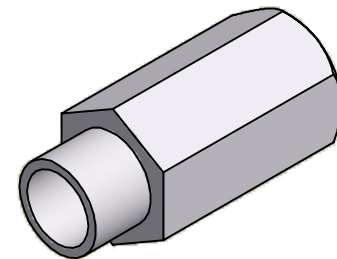

ISO SCALE 3 : 1

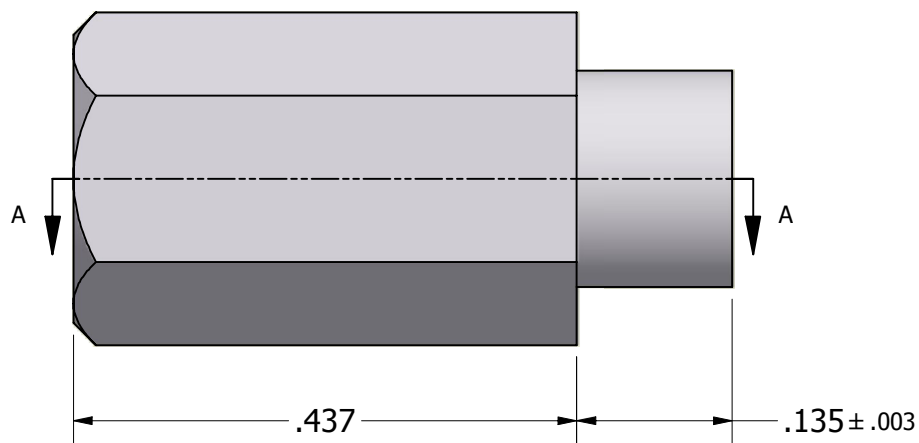

6-32 UNC-2B Thru

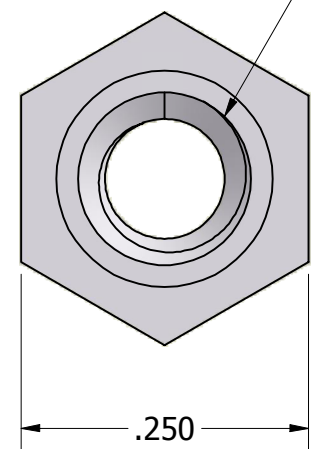

Tolerances Unless Otherwise Specified:

.xx Decimal: ± .02
 .xxx Decimal: ± .005
 Fraction: ± 1/64
 Angle: ± 2°

LYN-TRON, INC.

Part Number:

AA6920C-0.437

Description:

1/4 Hex Swage Standoff

Drawn By:

CAMERONC 10/29/2013

Gauge:

Material:

Aluminum (RoHS)

Scale:

6 : 1