

ISO SCALE 1 : 1

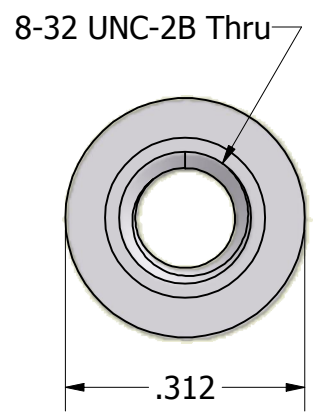
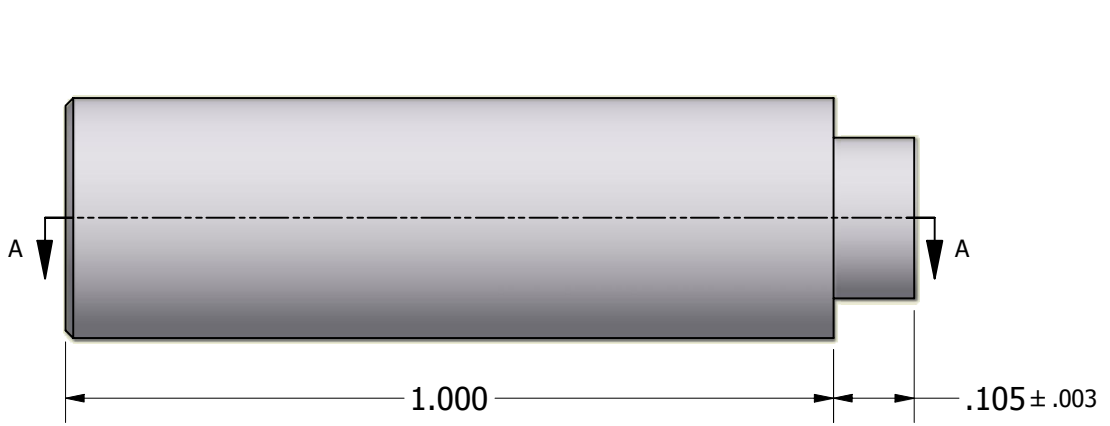

Tolerances Unless Otherwise Specified:
 .xx Decimal: ± .02
 .xxx Decimal: ± .005
 Fraction: ± 1/64
 Angle: ± 2°

LYN-TRON, INC.

Part Number:
AA6919B-1.000

Description:
5/16 Round Swage Standoff

Drawn By:
JEFFN 06/21/2010

Gauge:

Material:
Aluminum (RoHS)

Scale:
4 : 1