

SECTION A-A

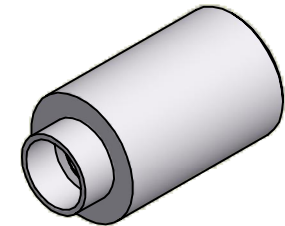

ISO SCALE 2 : 1

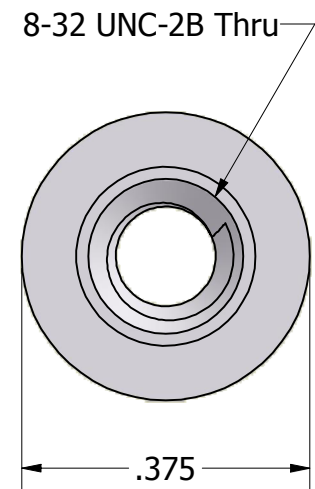
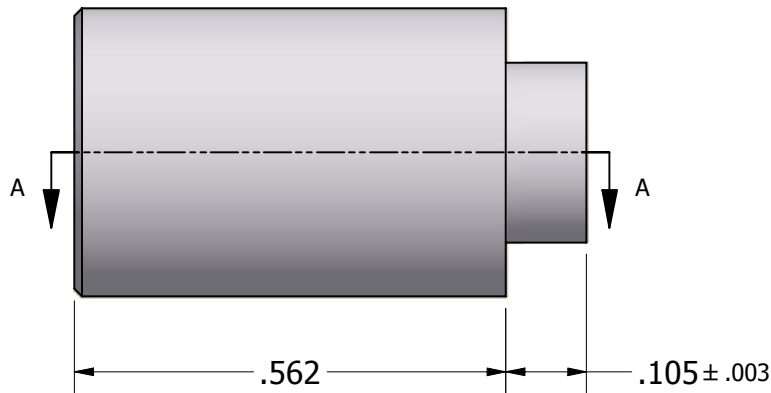

Tolerances Unless Otherwise Specified:

.xx Decimal: ± .02
.xxx Decimal: ± .005
Fraction: ± 1/64
Angle: ± 2°

LYN-TRON, INC.

Part Number:

AA6914B-0.562

Description:

3/8 Round Swage Standoff

Drawn By:

RICKZ 10/07/2011

Gauge:

Material:

Aluminum (RoHS)

Scale:

4 : 1