

SECTION A-A

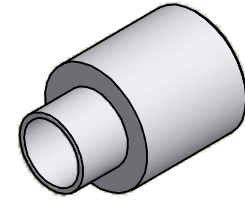

ISO SCALE 2 : 1

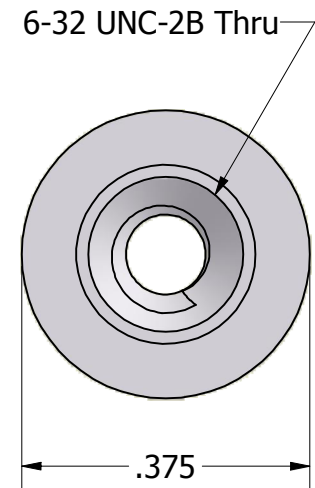
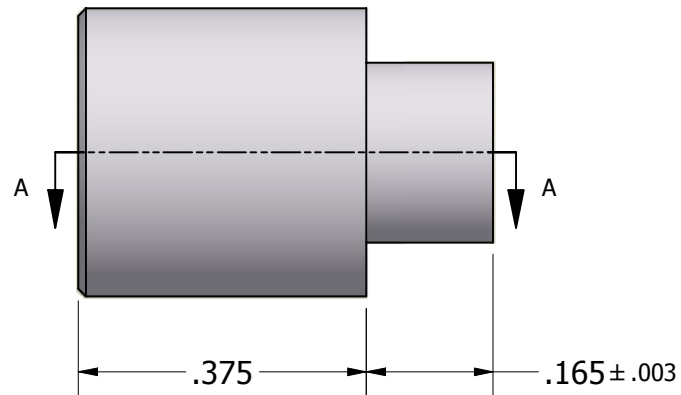

Tolerances Unless Otherwise Specified:

.xx Decimal: ± .02  
 .xxx Decimal: ± .005  
 Fraction: ± 1/64  
 Angle: ± 2°

**LYN-TRON, INC.**

Part Number:

**AA6912D-0.375**

Description:

**3/8 Round Swage Standoff**

Drawn By:

**JEFFN**

**06/21/2010**

Gauge:

Material:

**Aluminum (RoHS)**

Scale:

**4 : 1**