

SECTION A-A

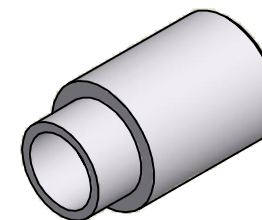

ISO SCALE 3 : 1

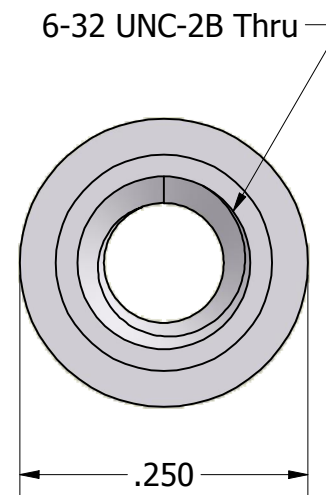
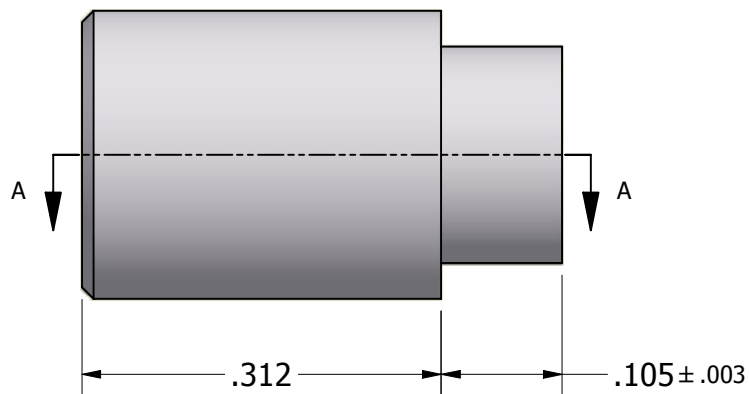

Tolerances Unless Otherwise Specified:

.xx Decimal: ± .02
.xxx Decimal: ± .005
Fraction: ± 1/64
Angle: ± 2°

LYN-TRON, INC.

Part Number:

AA6910B-0.312

Description:

1/4 Round Swage Standoff

Drawn By:

RICKZ

09/23/2011

Gauge:

Material:

Aluminum (RoHS)

Scale:

6 : 1