

SECTION A-A

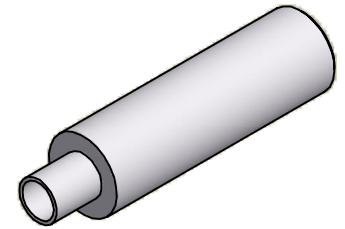

ISO SCALE 2 : 1

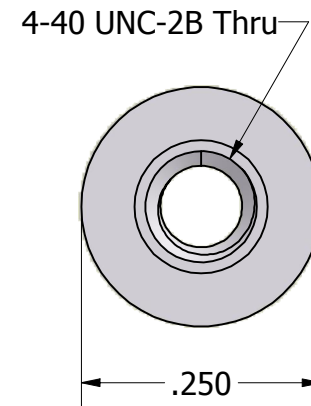
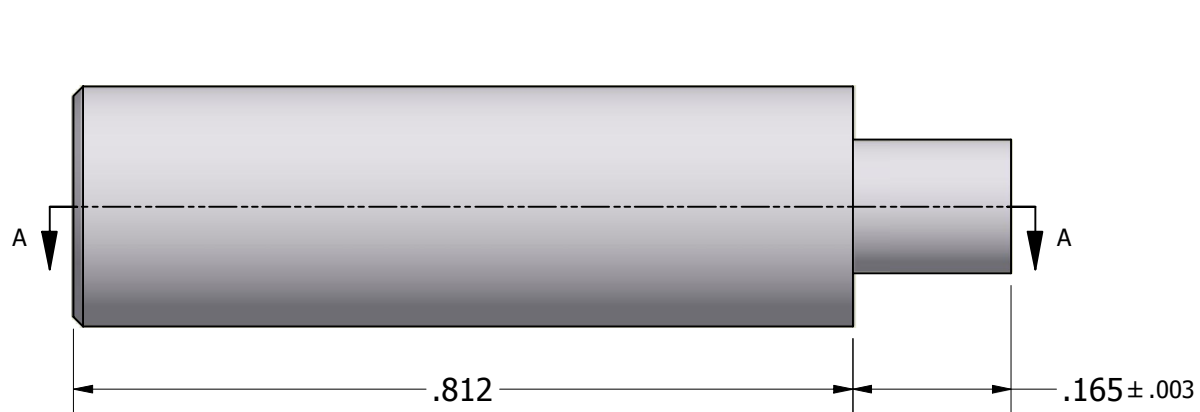

Tolerances Unless Otherwise Specified:

.xx Decimal: ± .02
 .xxx Decimal: ± .005
 Fraction: ± 1/64
 Angle: ± 2°

LYN-TRON, INC.

Part Number:

AA6905D-0.812

Description:

1/4 Round Swage Standoff

Drawn By:

RICKZ 09/23/2011

Gauge:

Material:

Aluminum (RoHS)

Scale:

5 : 1