

SECTION A-A

ISO SCALE 3 : 1

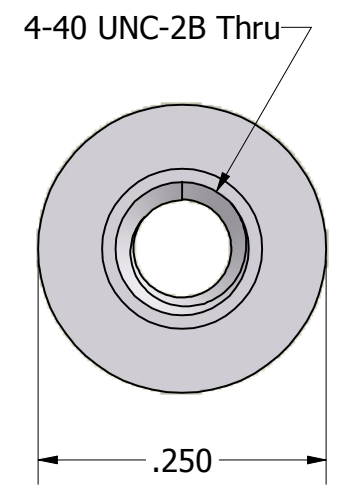
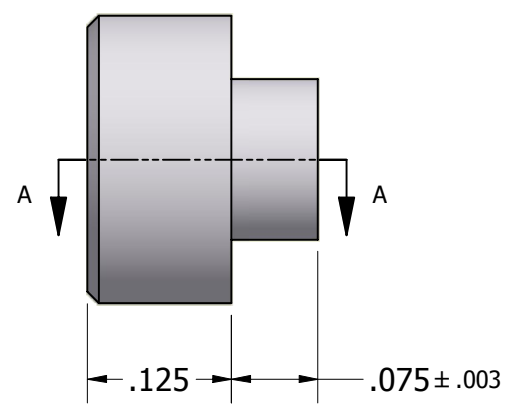

Tolerances Unless Otherwise Specified:
 .xx Decimal: $\pm .02$
 .xxx Decimal: $\pm .005$
 Fraction: $\pm 1/64$
 Angle: $\pm 2^\circ$

LYN-TRON, INC.

Part Number:
AA6905A-0.125

Description:
1/4 Round Swage Standoff

Drawn By:
RICKZ 09/23/2011

Gauge:

Material:
Aluminum (RoHS)

Scale:
6 : 1