

SECTION A-A

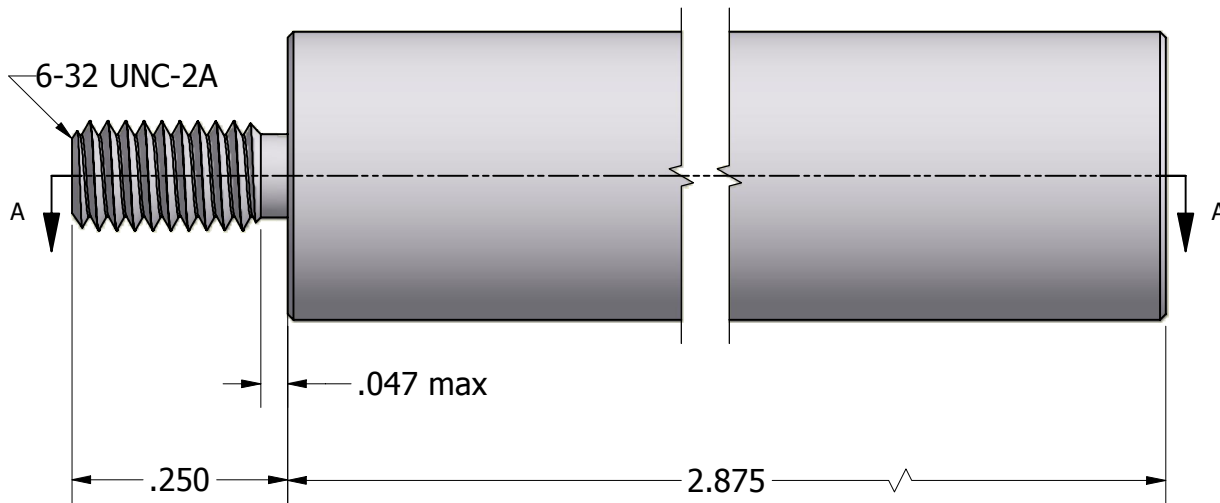

6-32 UNC-2B  
.375 min.

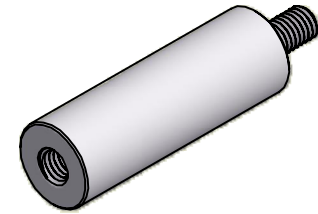
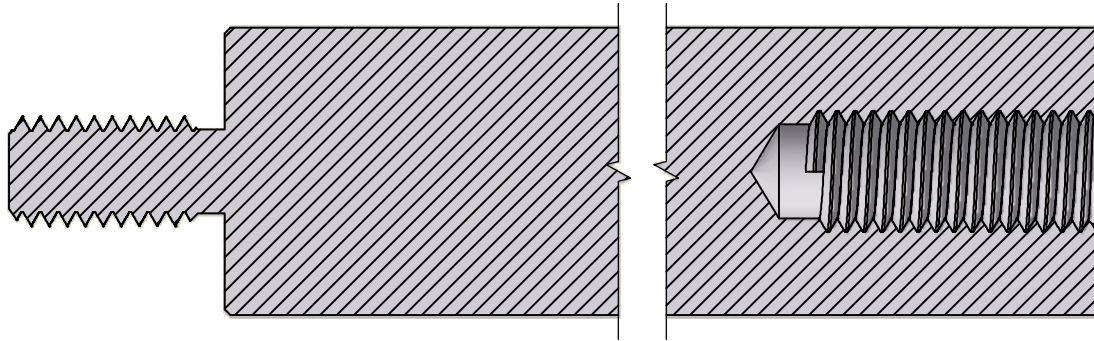
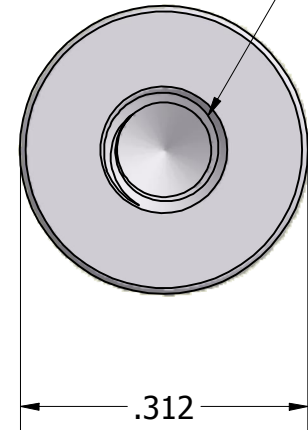

Tolerances Unless Otherwise Specified:

**.xx Decimal:** ± .02  
**.xxx Decimal:** ± .005  
**Fraction:** ± 1/64  
**Angle:** ± 2°

**LYN-TRON, INC.**

Part Number:

**AA6893-2.875**

Description:

**5/16 Round Male-Female Standoff**

Drawn By:

**COURTNEYS06/27/2011**

Gauge:

Material:

**Aluminum (RoHS)**

Scale:

**NTS**