

SECTION A-A

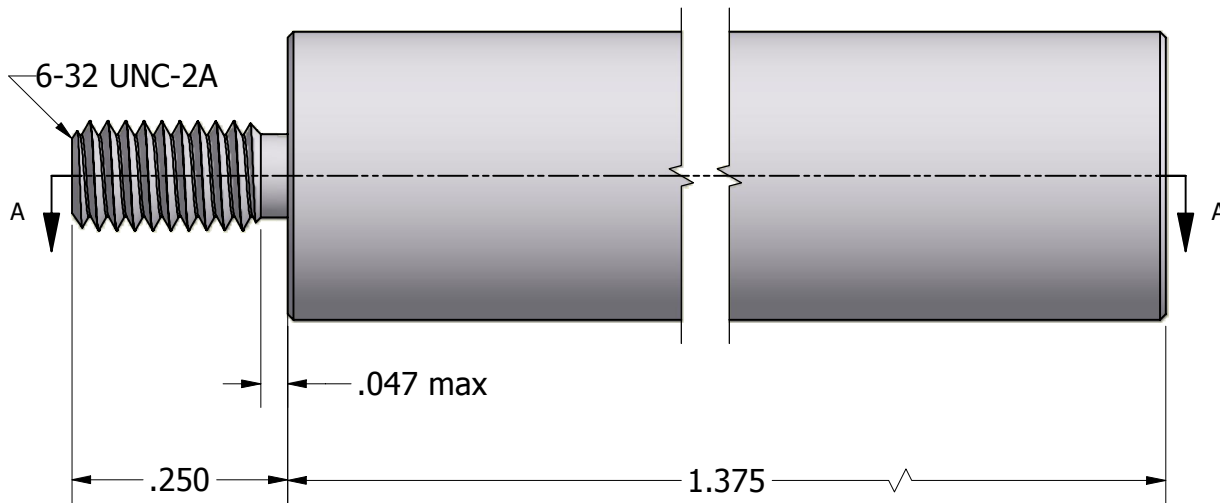

6-32 UNC-2B
.375 min.

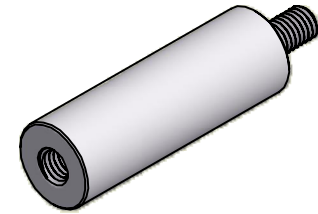
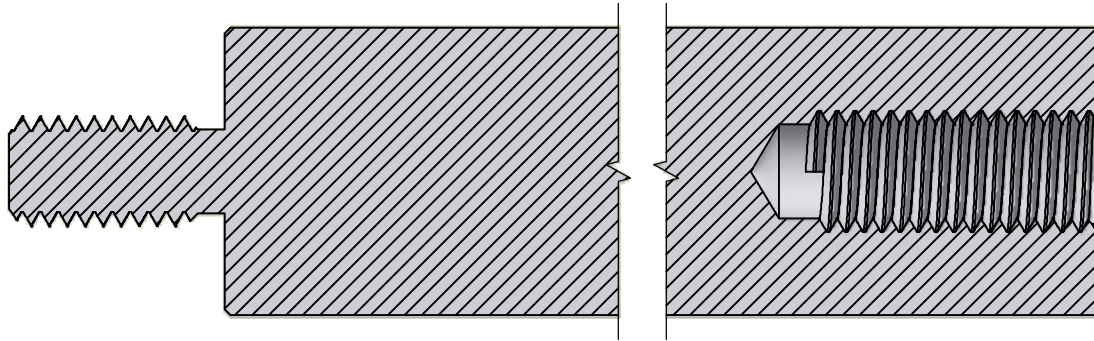
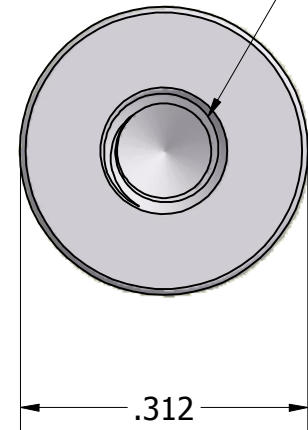

Tolerances Unless Otherwise Specified:

.xx Decimal: ± .02
.xxx Decimal: ± .005
Fraction: ± 1/64
Angle: ± 2°

LYN-TRON, INC.

Part Number:

AA6893-1.375

Description:

5/16 Round Male-Female Standoff

Drawn By:

COURTNEYS06/27/2011

Gauge:

Material:

Aluminum (RoHS)

Scale:

NTS