

SECTION A-A

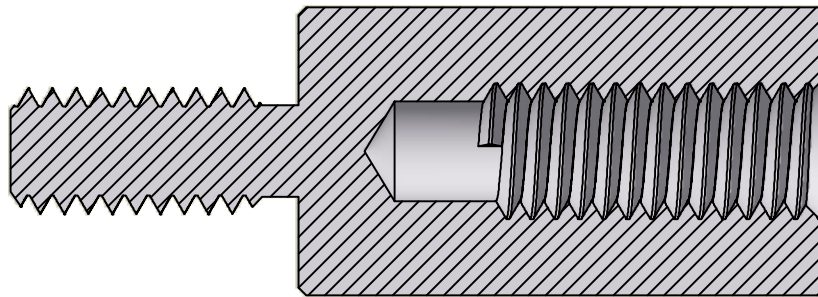

ISO SCALE 1 : 1

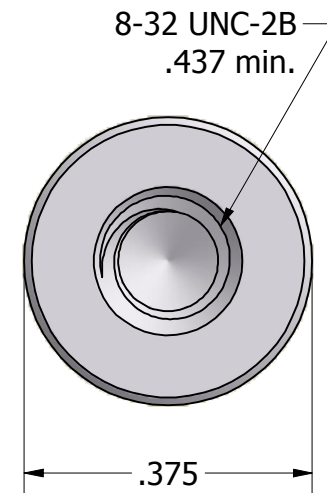
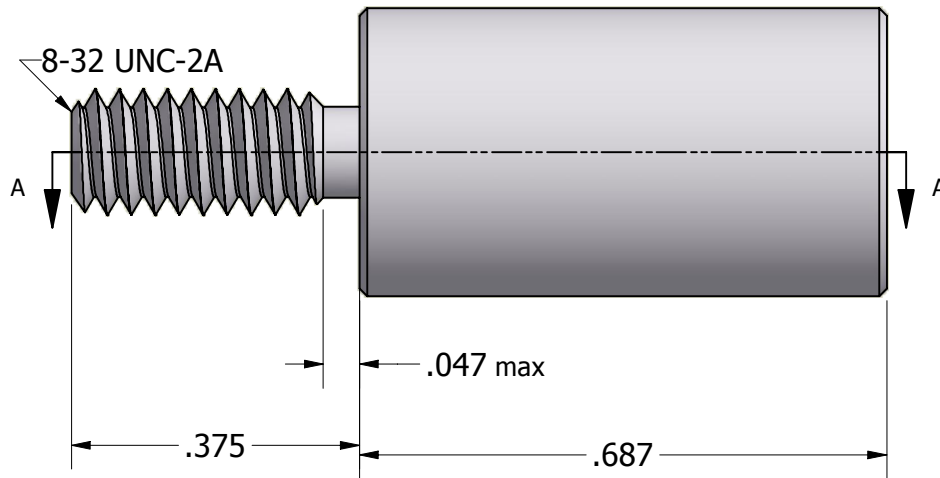

Tolerances Unless Otherwise Specified:

.xx Decimal: ± .02
.xxx Decimal: ± .005
Fraction: ± 1/64
Angle: ± 2°

LYN-TRON, INC.

Part Number:

AA6885-0.687

Description:

3/8 Round Male-Female Standoff

Drawn By:

KENANG 07/07/2011

Gauge:

Material:

Aluminum (RoHS)

Scale:

4 : 1