

SECTION A-A

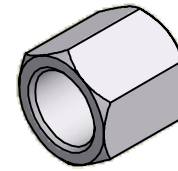

ISO SCALE 5 : 1

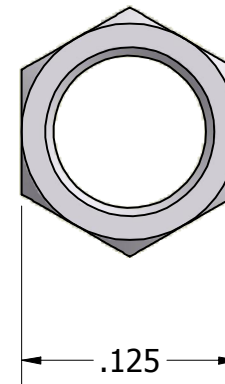
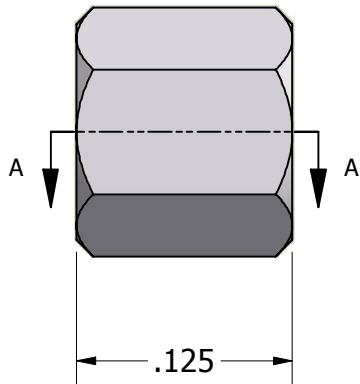

Tolerances Unless Otherwise Specified:

.xx Decimal: $\pm .02$
.xxx Decimal: $\pm .005$
Fraction: $\pm 1/64$
Angle: $\pm 2^\circ$

LYN-TRON, INC.

Part Number:

AA6358-02-0.125

Description:

1/8 Hex Spacer

Drawn By:

COURTNEYS06/15/2012

Gauge:

Material:

Aluminum (RoHS)

Scale:

9 : 1