

SECTION A-A

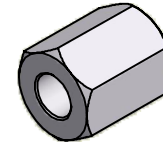

ISO SCALE 1 : 1

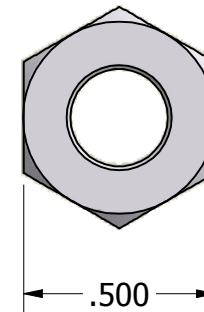
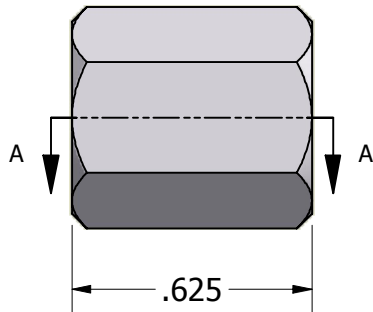

Tolerances Unless Otherwise Specified:

.xx Decimal: $\pm .02$
.xxx Decimal: $\pm .005$
Fraction: $\pm 1/64$
Angle: $\pm 2^\circ$

LYN-TRON, INC.

Part Number:

AA6355-25-0.625

Description:

1/2 Hex Spacer

Drawn By:

JEFFN

06/20/2010

Gauge:

Material:

Aluminum (RoHS)

Scale:

2 : 1