

SECTION A-A

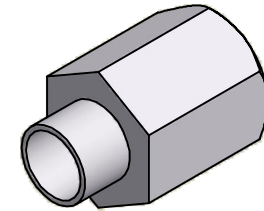

ISO SCALE 2 : 1

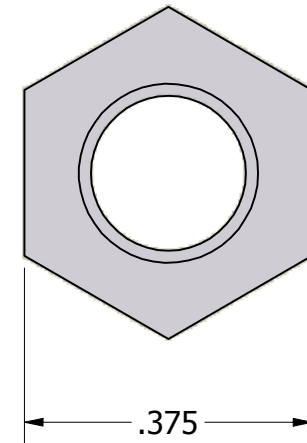
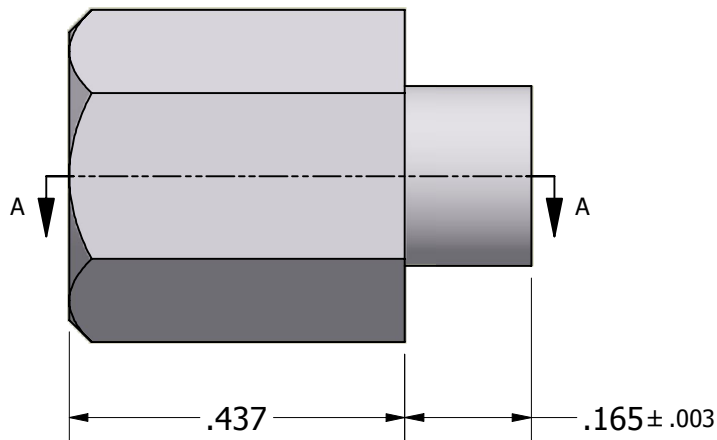

Tolerances Unless Otherwise Specified:

.xx Decimal: ± .02
.xxx Decimal: ± .005
Fraction: ± 1/64
Angle: ± 2°

LYN-TRON, INC.

Part Number:

AA6337D-0.437

Description:

3/8 Hex Swage Spacer

Drawn By:

COURTNEYS07/07/2010

Gauge:

Material:

Aluminum (RoHS)

Scale:

4 : 1