

SECTION A-A

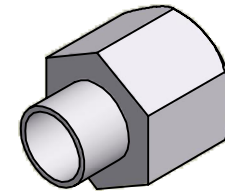

ISO SCALE 2 : 1

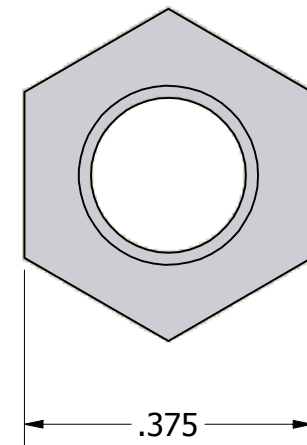
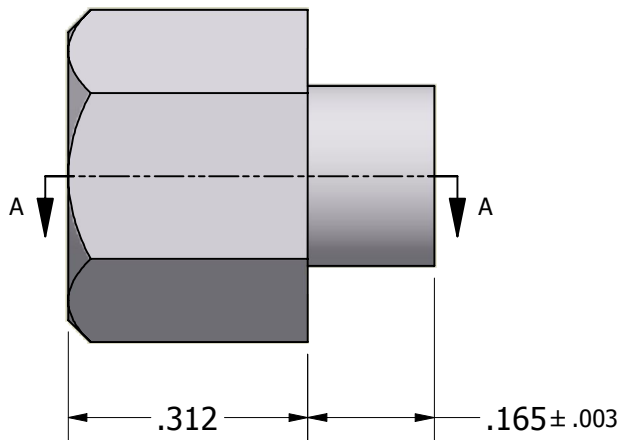

Tolerances Unless Otherwise Specified:

**.xx Decimal:** ± .02  
**.xxx Decimal:** ± .005  
**Fraction:** ± 1/64  
**Angle:** ± 2°

**LYN-TRON, INC.**

Part Number:

**AA6337D-0.312**

Description:

**3/8 Hex Swage Spacer**

Drawn By:

**COURTNEYS07/07/2010**

Gauge:

Material:

**Aluminum (RoHS)**

Scale:

**4 : 1**