

SECTION A-A

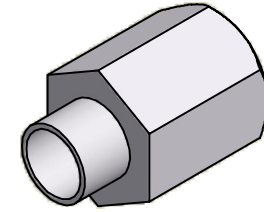

ISO SCALE 2 : 1

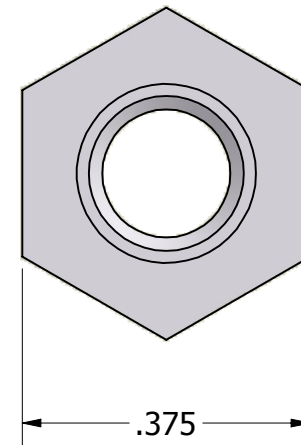
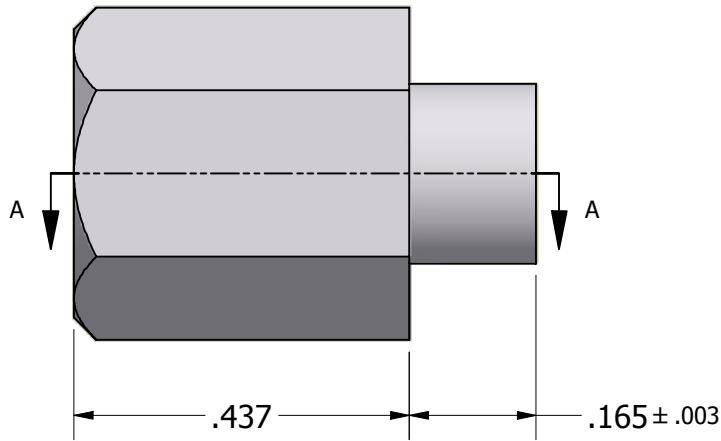

Tolerances Unless Otherwise Specified:

.xx Decimal: $\pm .02$
 .xxx Decimal: $\pm .005$
 Fraction: $\pm 1/64$
 Angle: $\pm 2^\circ$

LYN-TRON, INC.

Part Number:

AA6334D-0.437

Description:

3/8 Hex Swage Spacer

Drawn By:

COURTNEYS07/06/2010

Gauge:

Material:

Aluminum (RoHS)

Scale:

4 : 1