

SECTION A-A

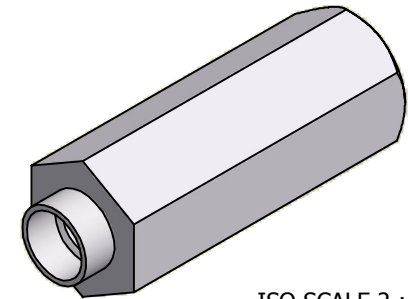

ISO SCALE 2 : 1

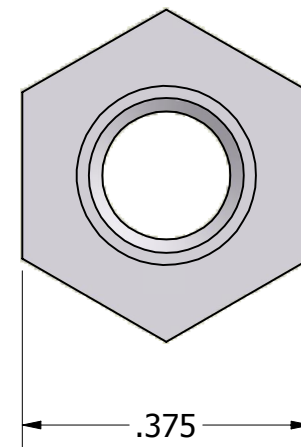
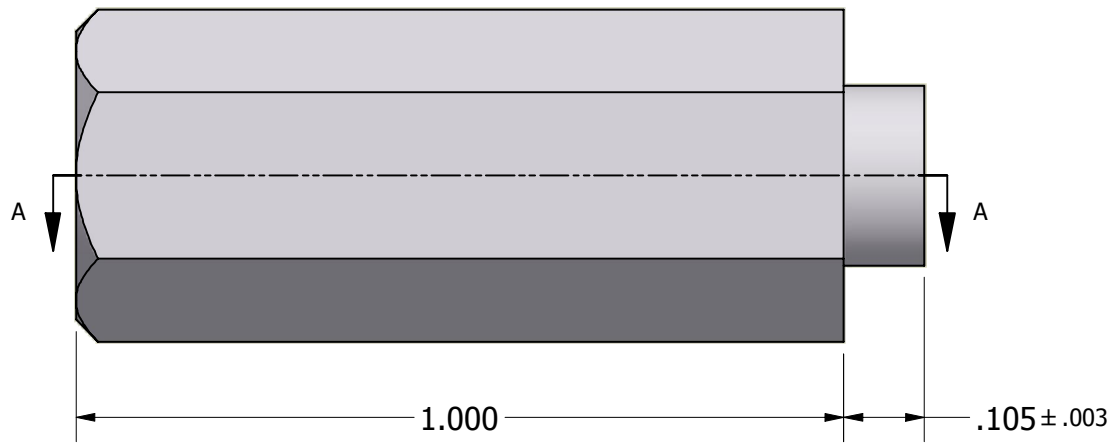

Tolerances Unless Otherwise Specified:

.xx Decimal: $\pm .02$
 .xxx Decimal: $\pm .005$
 Fraction: $\pm 1/64$
 Angle: $\pm 2^\circ$

LYN-TRON, INC.

Part Number:
AA6334B-1.000

Description:
3/8 Hex Swage Spacer

Drawn By:
COURTNEYS07/06/2010

Gauge:

Material:
Aluminum (RoHS)

Scale:
4 : 1