

SECTION A-A

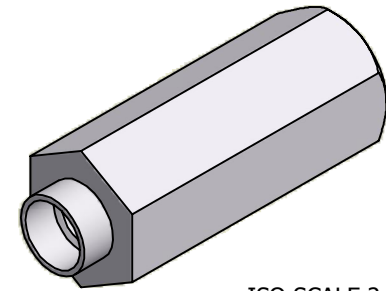

ISO SCALE 2 : 1

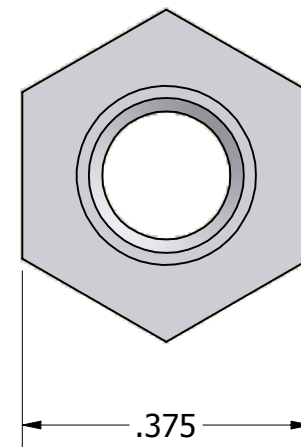
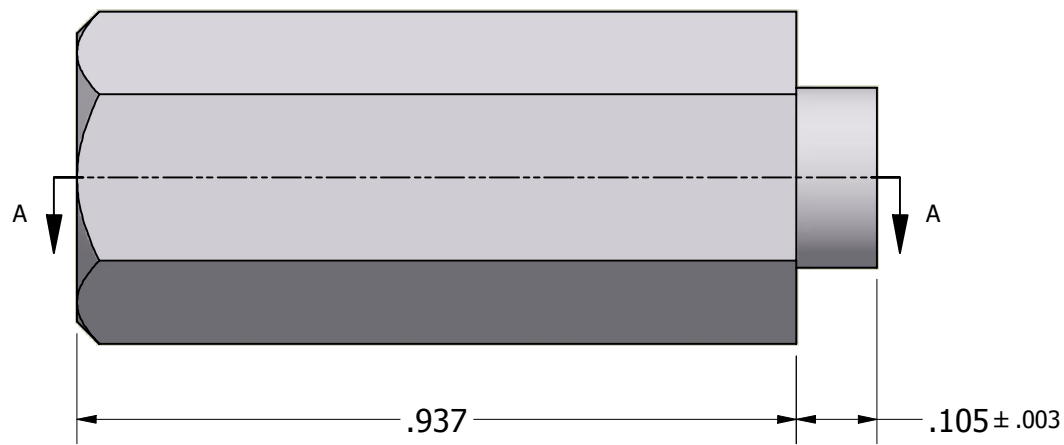

Tolerances Unless Otherwise Specified:

.xx Decimal: $\pm .02$
.xxx Decimal: $\pm .005$
Fraction: $\pm 1/64$
Angle: $\pm 2^\circ$

LYN-TRON, INC.

Part Number:

AA6334B-0.937

Description:

3/8 Hex Swage Spacer

Drawn By:

COURTNEYS07/06/2010

Gauge:

Material:

Aluminum (RoHS)

Scale:

4 : 1