

SECTION A-A

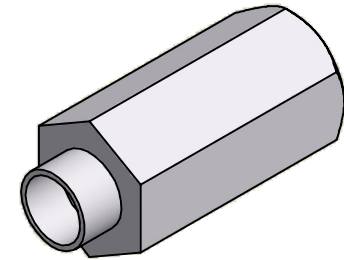

ISO SCALE 2 : 1

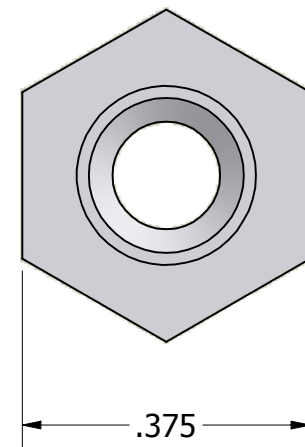
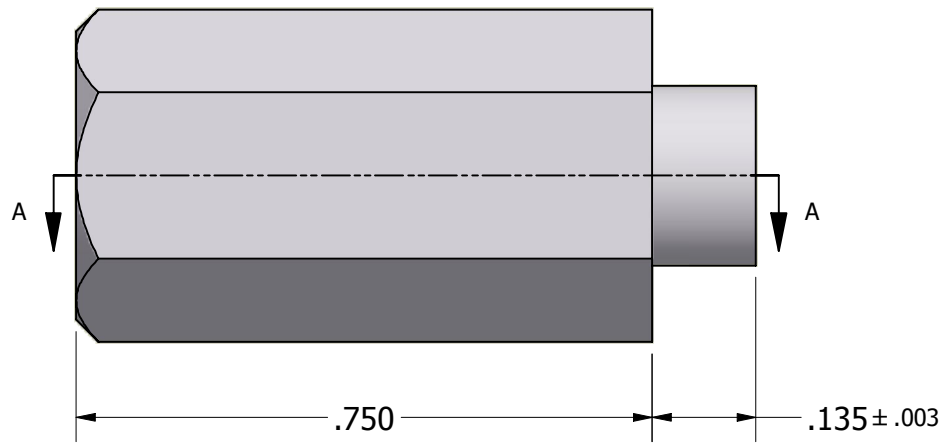

Tolerances Unless Otherwise Specified:

.xx Decimal:  $\pm .02$   
 .xxx Decimal:  $\pm .005$   
 Fraction:  $\pm 1/64$   
 Angle:  $\pm 2^\circ$

**LYN-TRON, INC.**

Part Number:

**AA6332C-0.750**

Description:

**3/8 Hex Swage Spacer**

Drawn By:

**COURTNEYS07/06/2010**

Gauge:

Material:

**Aluminum (RoHS)**

Scale:

**4 : 1**