

SECTION A-A

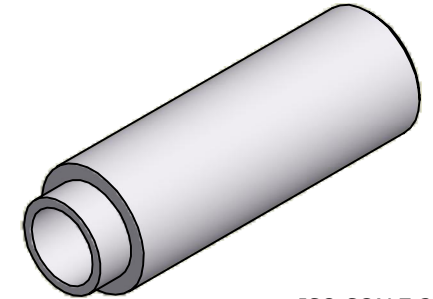

ISO SCALE 3 : 1

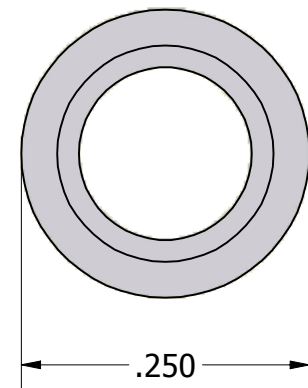
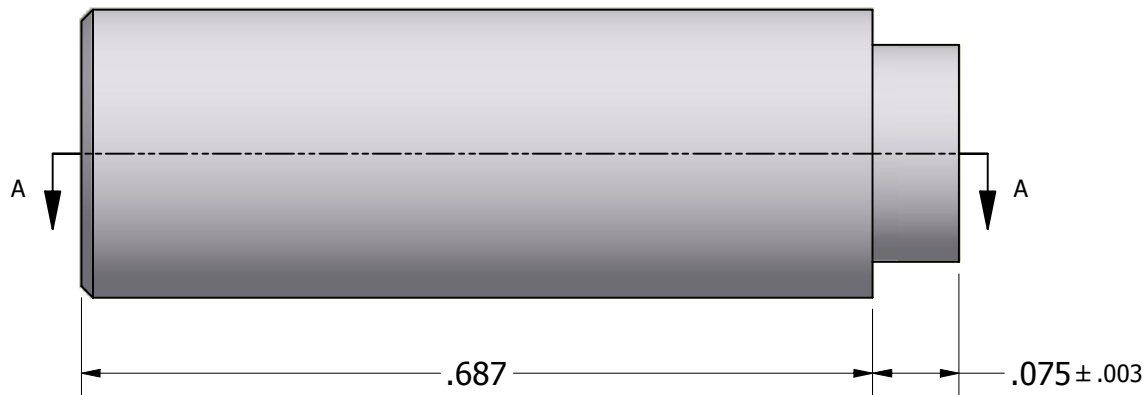

Tolerances Unless Otherwise Specified:

.xx Decimal: $\pm .02$
 .xxx Decimal: $\pm .005$
 Fraction: $\pm 1/64$
 Angle: $\pm 2^\circ$

LYN-TRON, INC.

Part Number:

AA6310A-0.687

Description:

1/4 Round Swage Spacer

Drawn By:

COURTNEYS07/02/2010

Gauge:

Material:

Aluminum (RoHS)

Scale:

6 : 1