

SECTION A-A

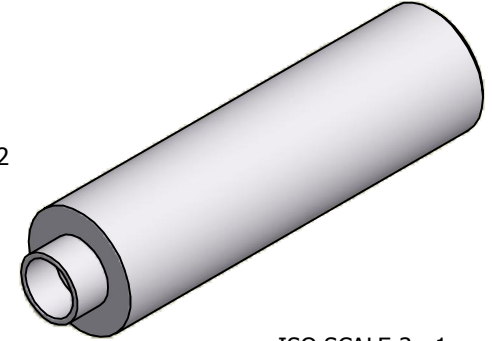

ISO SCALE 3 : 1

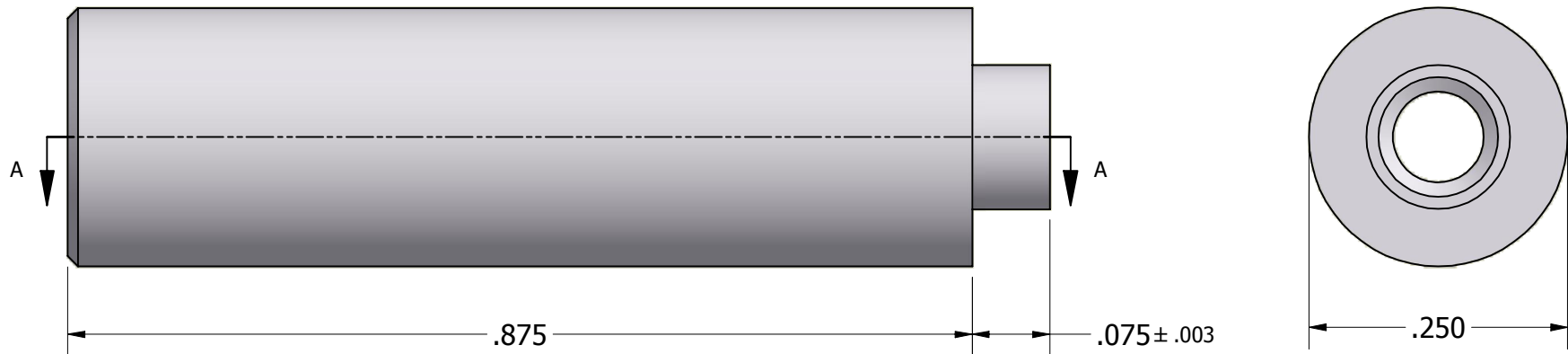

Tolerances Unless Otherwise Specified:

.xx Decimal:  $\pm .02$   
 .xxx Decimal:  $\pm .005$   
 Fraction:  $\pm 1/64$   
 Angle:  $\pm 2^\circ$

**LYN-TRON, INC.**

Part Number:

**AA6306A-0.875**

Description:

**1/4 Round Swage Spacer**

Drawn By:

**COURTNEYS07/02/2010**

Gauge:

Material:

**Aluminum (RoHS)**

Scale:

**6 : 1**