

SECTION A-A

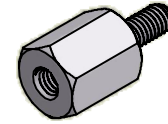

ISO SCALE 1 : 1

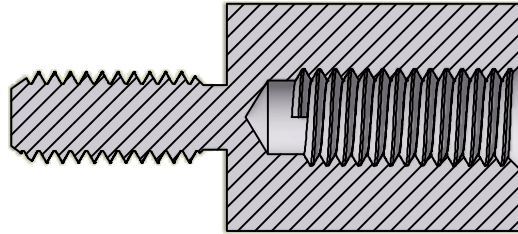
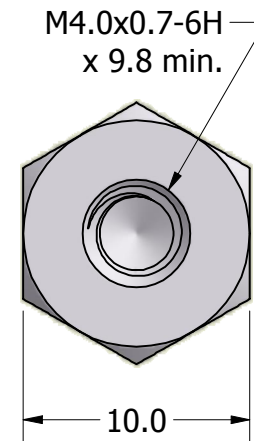
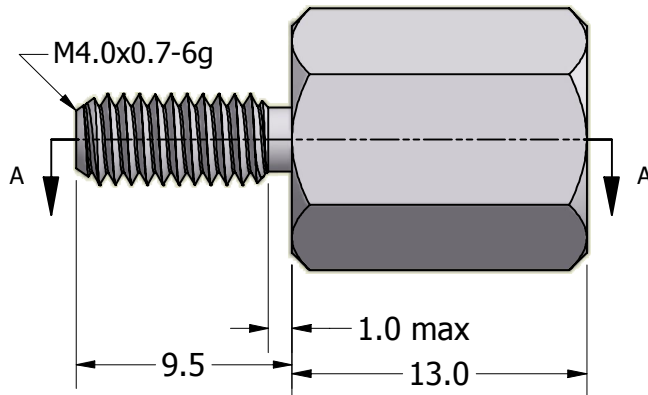

Tolerances Unless Otherwise Specified:

.x Decimal: ± 0.3
.xx Decimal: ± .13
Fraction: ± 1/64
Angle: ± 2°

LYN-TRON, INC.

Part Number:

AA5179-13.0

Description:

10mm Hex M4x.7 M/F Standoff

Drawn By:

COURTNEYS08/14/2012

Gauge:

Material:

Aluminum (RoHS)

Scale:

3 : 1