

SECTION A-A

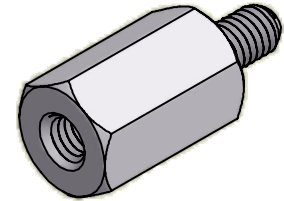

ISO SCALE 2 : 1

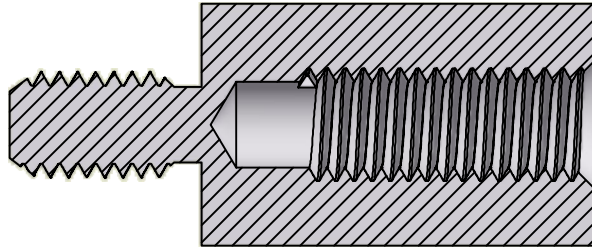
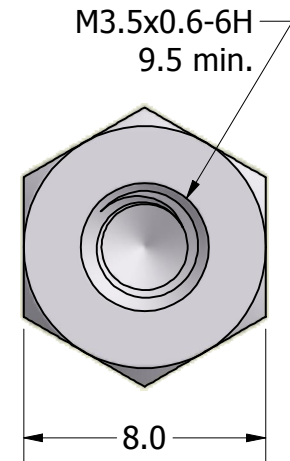
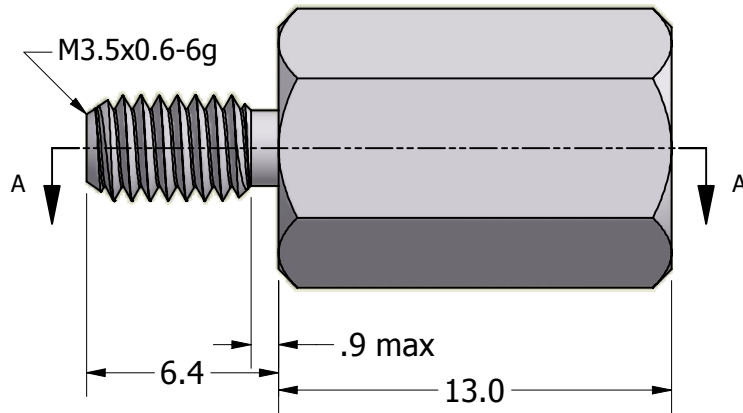

Tolerances Unless Otherwise Specified:

.x Decimal: ± 0.3
 .xx Decimal: $\pm .13$
 Fraction: $\pm 1/64$
 Angle: $\pm 2^\circ$

LYN-TRON, INC.

Part Number:

AA5175-13.0

Description:

8mm Hex M3.5x.6 M/F Standoff

Drawn By:

COURTNEYS08/07/2012

Gauge:

Material:

Aluminum (RoHS)

Scale:

4 : 1