

SECTION A-A

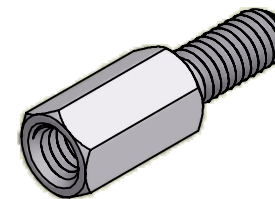

ISO SCALE 2 : 1

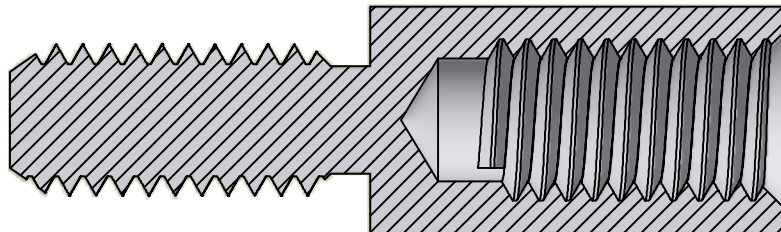
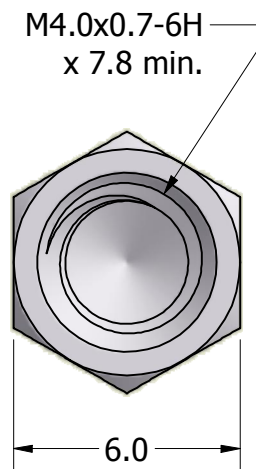
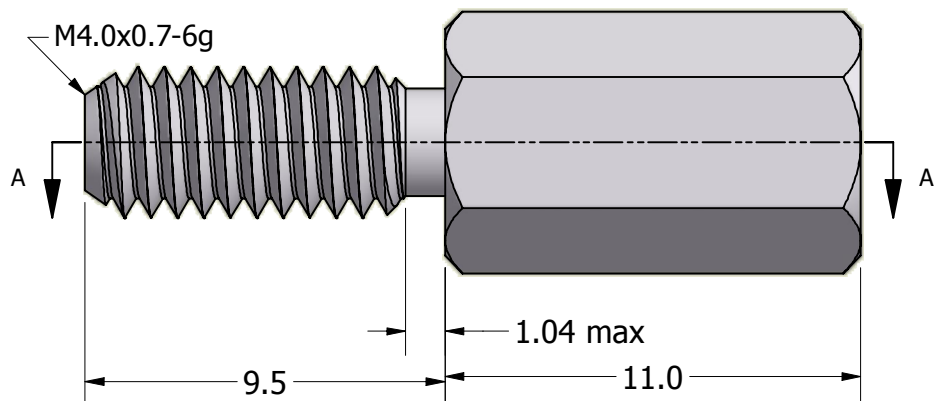

Tolerances Unless Otherwise Specified:

.x Decimal: ± 0.3
 .xx Decimal: ± .13
 Fraction: ± 1/64
 Angle: ± 2°

LYN-TRON, INC.

Part Number:
AA5174-11.0

Description:
6mm Hex M4x.7 M/F Standoff

Drawn By:
COURTNEYS08/28/2012

Gauge:
 Material:
Aluminum (RoHS)

Scale:
5 : 1