

SECTION A-A

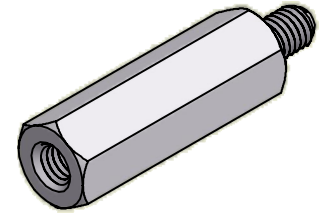

ISO SCALE 2 : 1

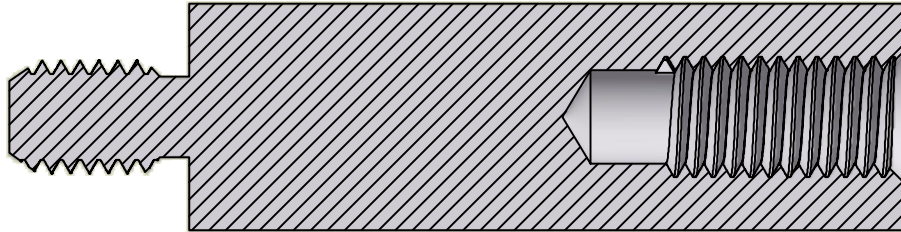
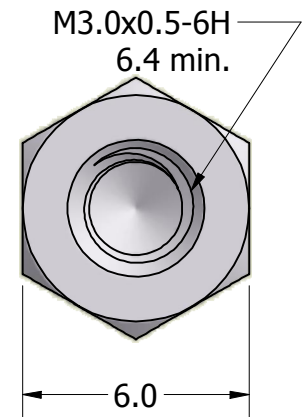
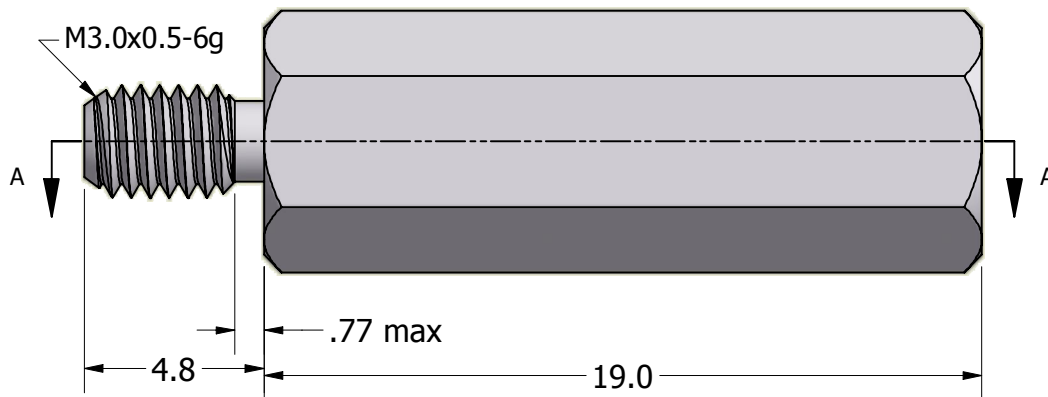

Tolerances Unless Otherwise Specified:

.x Decimal: ± 0.3
 .xx Decimal: $\pm .13$
 Fraction: $\pm 1/64$
 Angle: $\pm 2^\circ$

LYN-TRON, INC.

Part Number:

AA5172-19.0

Description:

6mm Hex M3x.5 M/F Standoff

Drawn By:

COURTNEYS08/03/2012

Gauge:

Material:

Aluminum (RoHS)

Scale:

5 : 1