

SECTION A-A

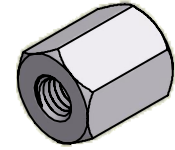

ISO SCALE 1 : 1

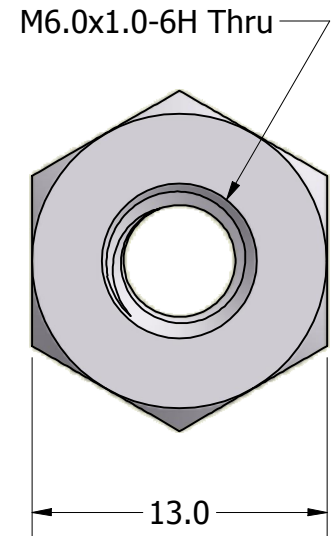
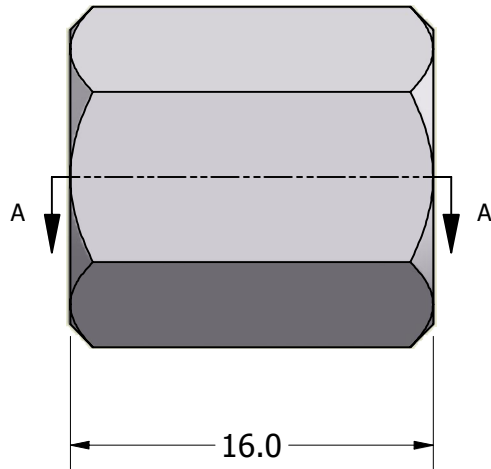

Tolerances Unless Otherwise Specified:

.x Decimal: ± 0.3
 .xx Decimal: $\pm .13$
 Fraction: $\pm 1/64$
 Angle: $\pm 2^\circ$

LYN-TRON, INC.

Part Number:

AA5088-6010-16.0

Description:

13mm Hex Standoff

Drawn By:

COURTNEYS08/16/2012

Gauge:

Material:

Aluminum (RoHS)

Scale:

3 : 1