

SECTION A-A

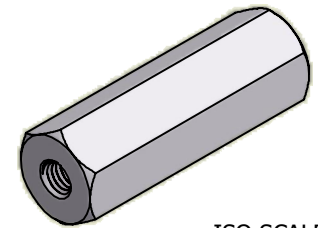

ISO SCALE 1 : 1

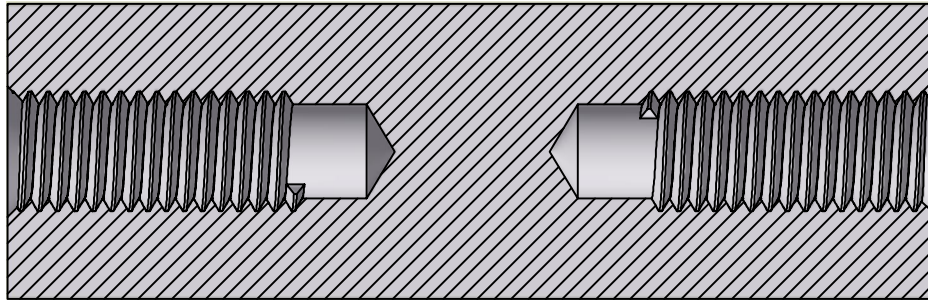
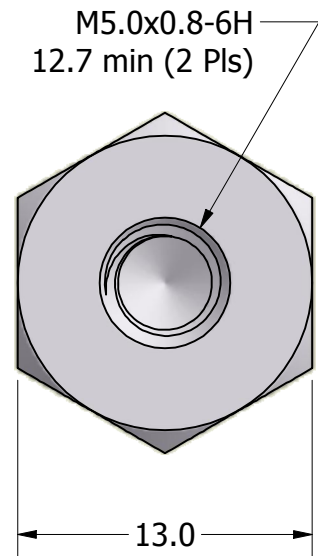
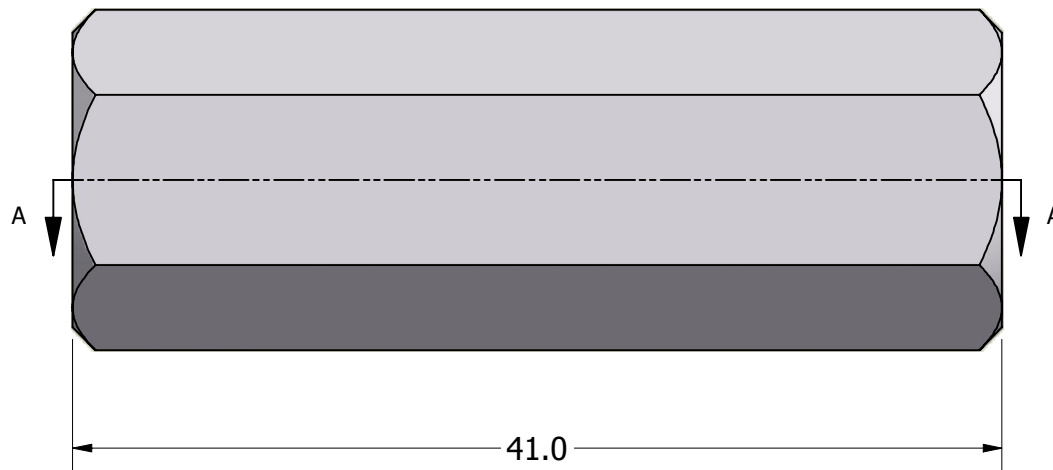

Tolerances Unless Otherwise Specified:

.x Decimal: ± 0.3
 .xx Decimal: $\pm .13$
 Fraction: $\pm 1/64$
 Angle: $\pm 2^\circ$

LYN-TRON, INC.

Part Number:
AA5088-5080-41.0

Description:
13mm Hex F/F Standoff

Drawn By:
COURTNEYS08/16/2012

Gauge:

Material:
Aluminum (RoHS)

Scale:
3 : 1