

SECTION A-A

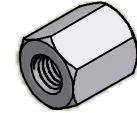

ISO SCALE 1 : 1

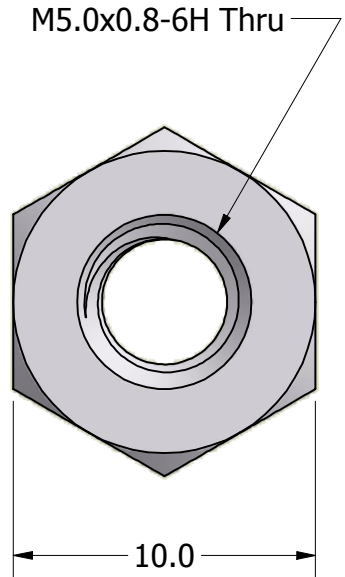
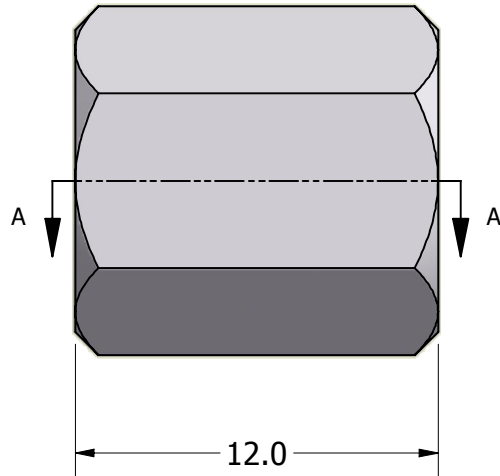

Tolerances Unless Otherwise Specified:

**.x Decimal:** ± 0.3  
**.xx Decimal:** ± .13  
**Fraction:** ± 1/64  
**Angle:** ± 2°

**LYN-TRON, INC.**

Part Number:

**AA5086-5080-12.0**

Description:

**10mm Hex Standoff**

Drawn By:

**COURTNEYS08/14/2012**

Gauge:

Material:

**Aluminum (RoHS)**

Scale:

**4 : 1**