

SECTION A-A

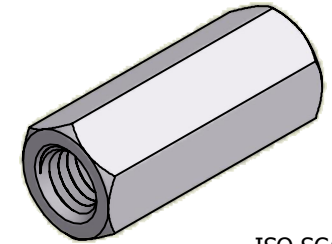

ISO SCALE 2 : 1

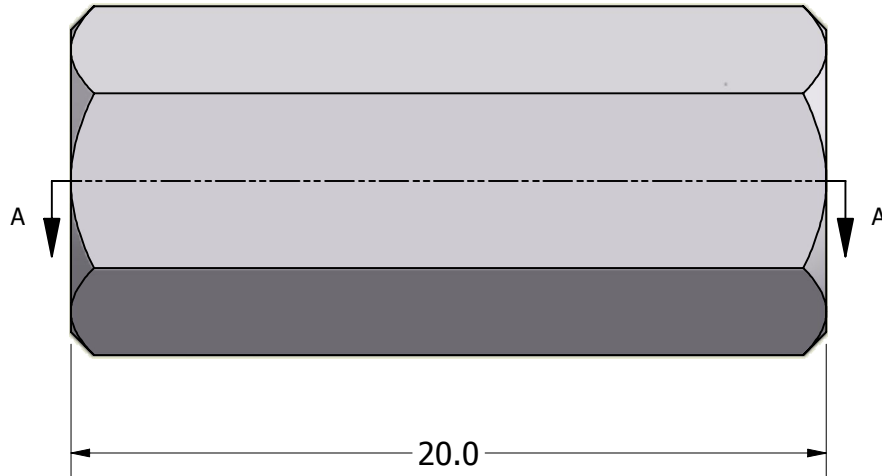

M5.0x0.8-6H Thru

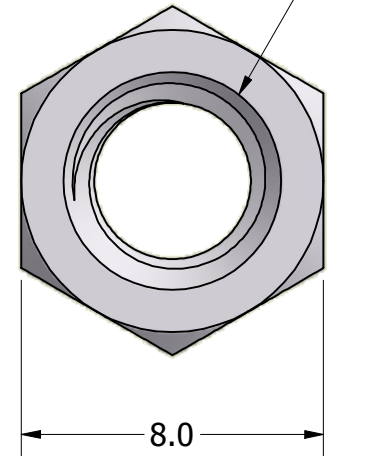

Tolerances Unless Otherwise Specified:

.x Decimal: ± 0.3
 .xx Decimal: $\pm .13$
 Fraction: $\pm 1/64$
 Angle: $\pm 2^\circ$

LYN-TRON, INC.

Part Number:

AA5085-5080-20.0

Description:

8mm Hex Standoff

Drawn By:

COURTNEYS08/09/2012

Gauge:

Material:

Aluminum (RoHS)

Scale:

5 : 1