

SECTION A-A

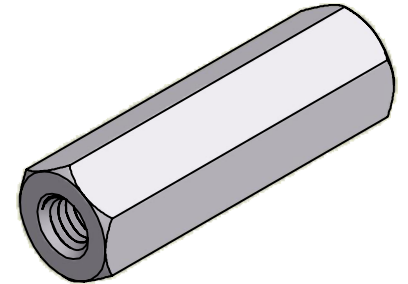

ISO SCALE 2 : 1

M4.0x0.7-6H
11.1 min (2 Pls)

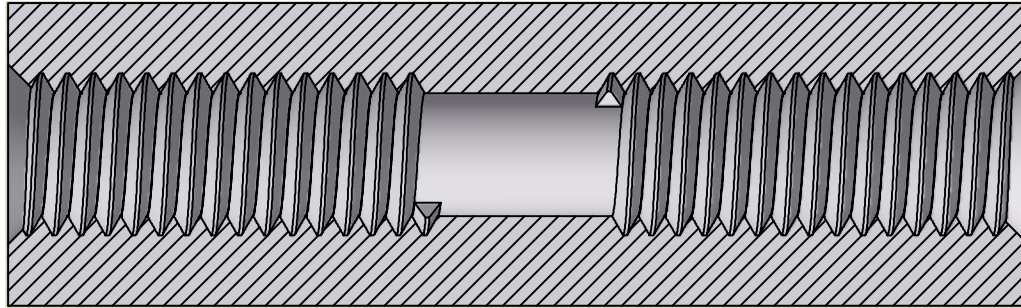
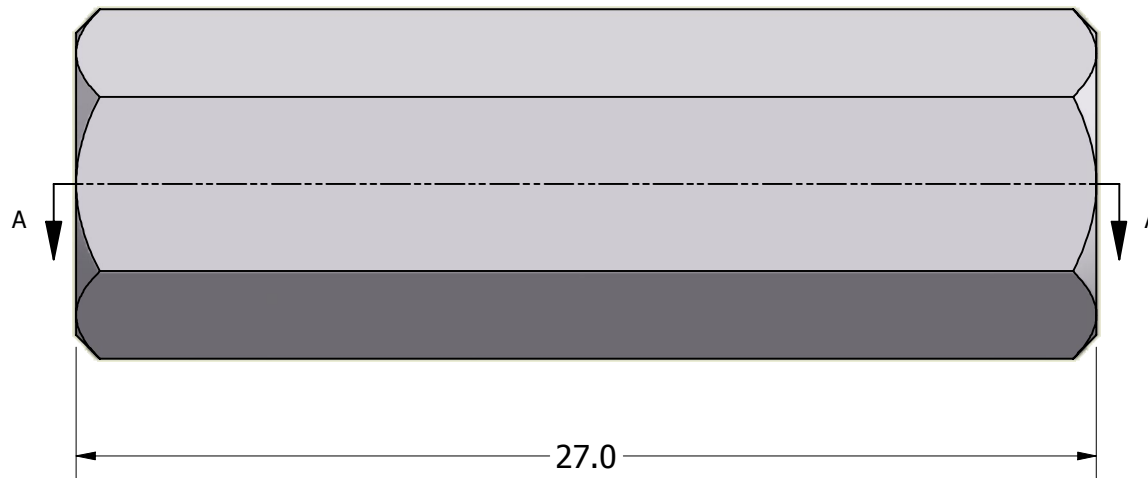
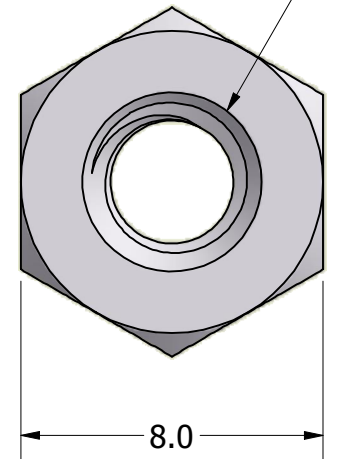

Tolerances Unless Otherwise Specified:

.x Decimal: ± 0.3
.xx Decimal: ± .13
Fraction: ± 1/64
Angle: ± 2°

LYN-TRON, INC.

Part Number:

AA5085-4070-27.0

Description:

8mm Hex F/F Standoff

Drawn By:

COURTNEYS08/09/2012

Gauge:

Material:

Aluminum (RoHS)

Scale:

5 : 1