

SECTION A-A

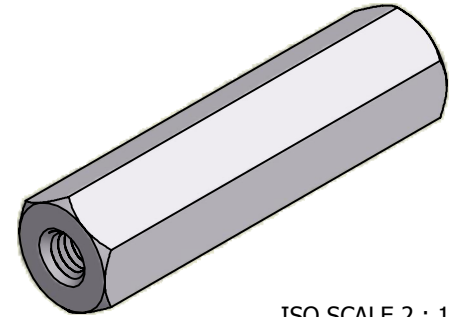

ISO SCALE 2 : 1

M3.5x0.6-6H
9.5 min (2 Pls)

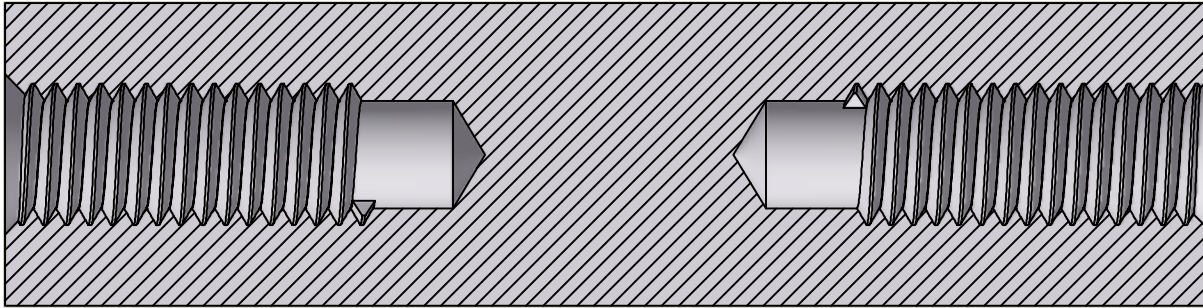
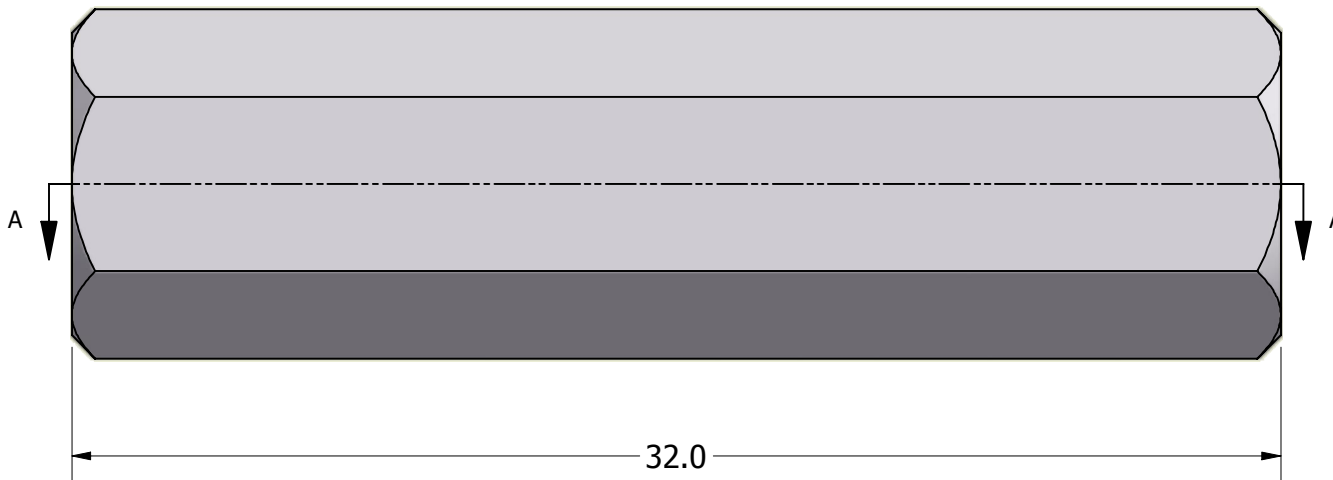
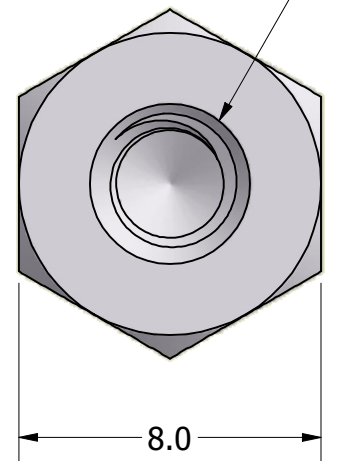

Tolerances Unless Otherwise Specified:

.x Decimal: ± 0.3
.xx Decimal: ± .13
Fraction: ± 1/64
Angle: ± 2°

LYN-TRON, INC.

Part Number:

AA5085-3560-32.0

Description:

8mm Hex F/F Standoff

Drawn By:

COURTNEYS08/09/2012

Gauge:

Material:

Aluminum (RoHS)

Scale:

5 : 1