

SECTION A-A

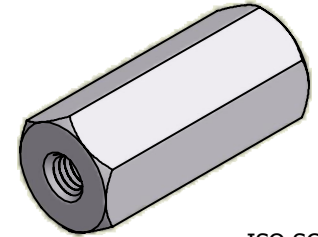

ISO SCALE 2 : 1

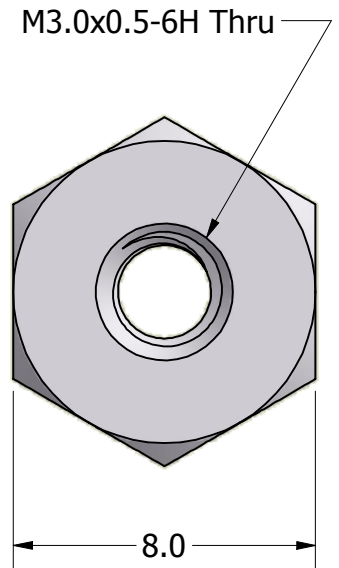
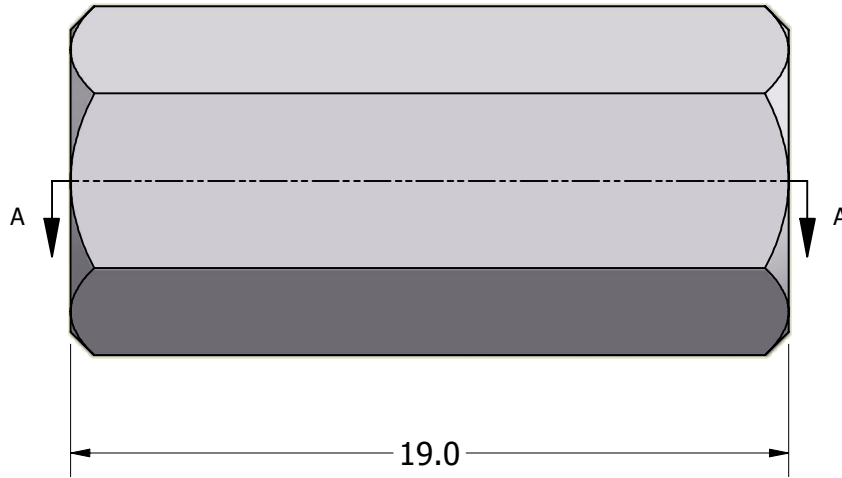

Tolerances Unless Otherwise Specified:

- .x Decimal:** ± 0.3
- .xx Decimal:** ± .13
- Fraction:** ± 1/64
- Angle:** ± 2°

**LYN-TRON, INC.**

Part Number:

**AA5085-3050-19.0**

Description:

**8mm Hex Standoff**

Drawn By:

**COURTNEYS08/09/2012**

Gauge:

Material:

**Aluminum (RoHS)**

Scale:

**5 : 1**