

SECTION A-A

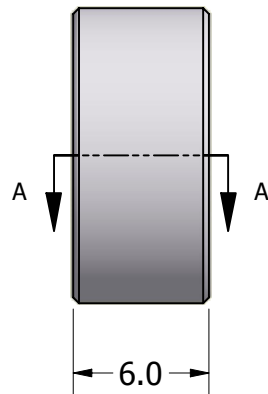

ISO SCALE 1 : 1



M6.0x1.0-6H Thru

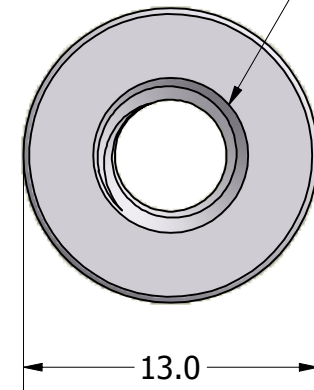

Tolerances Unless Otherwise Specified:

**.x Decimal:** ± 0.3  
**.xx Decimal:** ± .13  
**Fraction:** ± 1/64  
**Angle:** ± 2°

**LYN-TRON, INC.**

Part Number:

**AA5076-6010-06.0**

Description:

**13mm Rnd Standoff**

Drawn By:

**COURTNEYS02/26/2011**

Gauge:

Material:

**Aluminum (RoHS)**

Scale:

**3 : 1**