

SECTION A-A

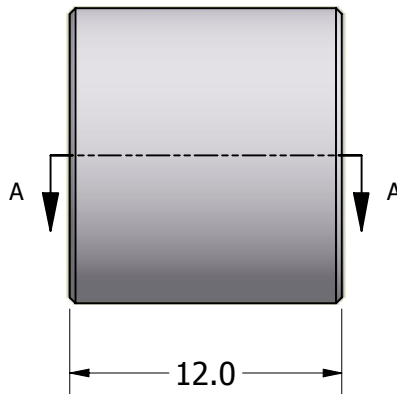

ISO SCALE 1 : 1



M4.0x0.7-6H Thru

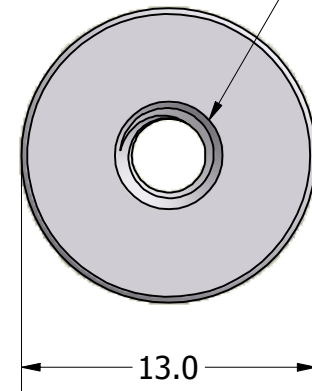

Tolerances Unless Otherwise Specified:

.x Decimal: ± 0.3
.xx Decimal: ± .13
Fraction: ± 1/64
Angle: ± 2°

LYN-TRON, INC.

Part Number:

AA5076-4070-12.0

Description:

13mm Rnd Standoff

Drawn By:

COURTNEYS02/26/2011

Gauge:

Material:

Aluminum (RoHS)

Scale:

3 : 1