

SECTION A-A

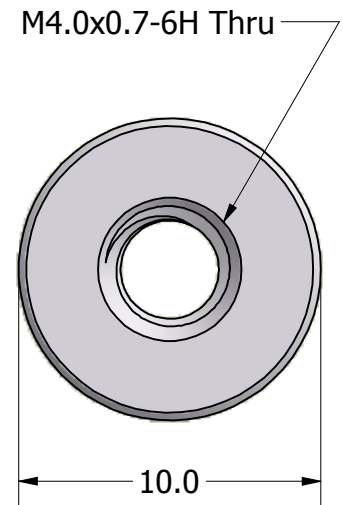

ISO SCALE 1 : 1

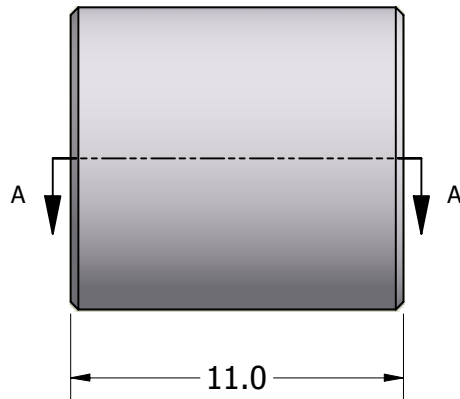

Tolerances Unless Otherwise Specified:

.x Decimal: ± 0.3
.xx Decimal: ± .13
Fraction: ± 1/64
Angle: ± 2°

LYN-TRON, INC.

Part Number:
AA5074-4070-11.0

Description:
10mm Rnd Standoff

Drawn By:
COURTNEYS02/25/2011

Gauge:

Material:
Aluminum (RoHS)

Scale:
4 : 1