

SECTION A-A

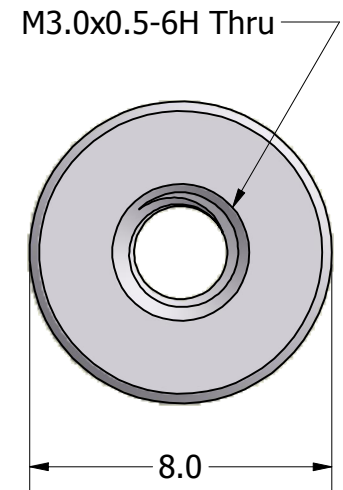

ISO SCALE 2 : 1

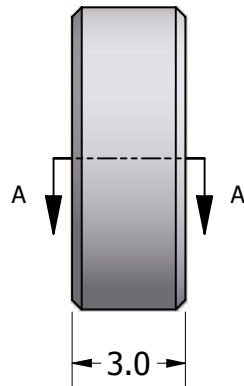

Tolerances Unless Otherwise Specified:

.x Decimal: ± 0.3
.xx Decimal: ± .13
Fraction: ± 1/64
Angle: ± 2°

LYN-TRON, INC.

Part Number:
AA5073-3050-03.0

Description:
8mm Rnd Standoff

Drawn By:
COURTNEYS02/25/2011

Gauge:

Material:
Aluminum (RoHS)

Scale:
5 : 1