

SECTION A-A

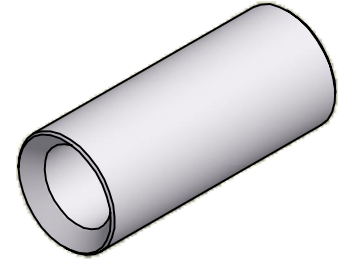

ISO SCALE 3 : 1

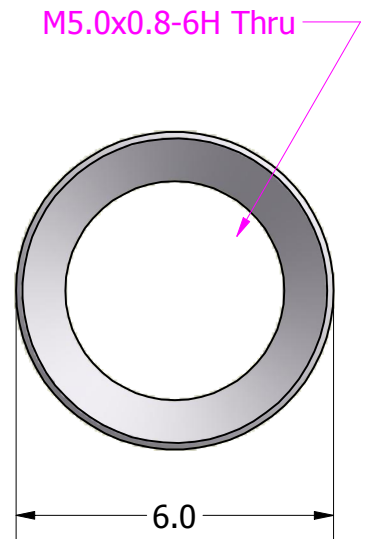
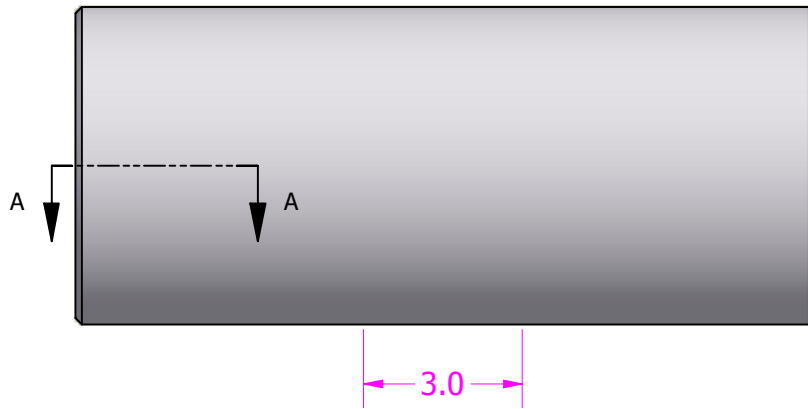

Tolerances Unless Otherwise Specified:

.x Decimal:  $\pm 0.3$   
 .xx Decimal:  $\pm .13$   
 Fraction:  $\pm 1/64$   
 Angle:  $\pm 2^\circ$

**LYN-TRON, INC.**

Part Number:  
**AA5071-5080-14.0**

Description:  
**6mm Rnd Standoff**

Drawn By:  
**COURTNEYS02/25/2011**

Gauge:

Material:  
**Aluminum (RoHS)**

Scale:  
**7 : 1**